

User Manual

FM

ECO3 / PRO3 / TCO3 /



Version 7. Last update 2013-08-27



Content

1. INTRODUCTION – PAGE 4-6

1.1. ACRONYMS AND TERMS USED IN DOCUMENT – PAGE 4

1.2. LEGAL NOTICE – PAGE 4

1.3. SAFETY REQUIREMENTS – PAGE 5-6

2. FM-PRO3 – PAGE 7-16

2.1. BASIC DESCRIPTION – PAGE 7

2.2. PACKAGE CONTENTS – PAGE 8

2.3. ADDITIONAL ACCESSORIES – PAGE 8

2.4. BASIC CHARACTERISTICS – PAGE 9

2.5. TECHNICAL FEATURES – PAGE 10

2.6. FM-PRO3 DIMENSIONS – PAGE 11

2.7. LED STATUSES – PAGE 12-13

2.8. PINOUT CONNECTION, USB – PAGE 14-15

2.9. SPECIAL FEATURES – PAGE 15

2.10. QUALIFICATION AND CERTIFICATION – PAGE 16

3. FM-ECO3 – PAGE 17-24

3.1. BASIC DESCRIPTION – PAGE 17

3.2. PACKAGE CONTENTS – PAGE 18

3.3. ADDITIONAL ACCESSORIES – PAGE 18

3.4. BASIC CHARACTERISTICS – PAGE 19

3.5. TECHNICAL FEATURES – PAGE 20

3.6. FM-ECO3 DIMENSIONS – PAGE 21

3.7. LED STATUSES – PAGE 22

3.8. PINOUT CONNECTION, USB – PAGE 23-24

3.9. SPECIAL FEATURES – PAGE 24

3.10. QUALIFICATION AND CERTIFICATION – PAGE 24

4. FM-TCO3 – PAGE 25-34

4.1. BASIC DESCRIPTION – PAGE 25

4.2. PACKAGE CONTENTS – PAGE 26

4.3. ADDITIONAL ACCESSORIES – PAGE 26

4.4. BASIC CHARACTERISTICS – PAGE 27

4.5. TECHNICAL FEATURES – PAGE 28

4.6. FM-TCO3 DIMENSIONS – PAGE 29

4.7. LED STATUSES – PAGE 30-31

4.8. PINOUT CONNECTION, USB – PAGE 32-33

4.9. SPECIAL FEATURES – PAGE 33-34

4.10. QUALIFICATION AND CERTIFICATION – PAGE 34

5. INSTALLATION AND CONFIGURATION INSTRUCTIONS – PAGE 35-

5.1. MODULE INSTALLATION – PAGE 35-36

5.2. DEVICE CONNECTION TO A PERSONAL COMPUTER – PAGE 37

5.2.1. SYSTEM REQUIREMENTS – PAGE 37

5.2.2. PREPARATION FOR CONNECTION – PAGE 37

5.2.3. DRIVER INSTALLATION – PAGE 38-42

5.3. CONFIGURATOR – PAGE 42

5.3.1. INTERFACING TO COM PORT – PAGE 42-44

5.3.2. GLOBAL PARAMETER CONFIGURATION – PAGE 44-46

5.3.3. PROFILE CONFIGURATION – PAGE 47-55

5.3.4. SAVING AND LOADING CONFIGURATION – PAGE 55-57

5.3.5. CONFIGURATION EXCHANGE WITH A DEVICE – PAGE 57

5.4. FIRMWARE UPDATE – PAGE 57-58

5.5. APPENDIX – IO LIST – PAGE 59-67

1. INTRODUCTION

1.1. ACRONYMS AND TERMS USED IN DOCUMENT

- PC – Personal Computer;
- FM Terminal – FM-Pro3 / FM-Tco3 / FM-Eco3 series device;
- GPRS – General Packet Radio Service;
- GPS – Global Positioning System;
- GSM – Global System for Mobile Communications;
- GLONASS – GLObal NAVigation Satellite System;
- SMS – Short Message Service;
- AC/DC – Alternating Current/Direct Current;
- Record – Data which is stored in FM 3 memory. Data contains GPS and I/O Information;
- FMS – An optional standard interface of different truck manufacturers;
- Simplified RS232 – connection standard between different pieces of equipment. Simplified RS232 has only Rx and Tx lines;
 - RS485 – connection standard between different (multiple) pieces of equipment (physically connected with Port A, where Simplified RS232 is placed). We can configure a device to use RS485 or RS232 as Port A;
- LED – Light Emitting Diode;
- CAN-bus – FMS standard interface;
- I/O – Inputs / Outputs;
- OBD - On-Board Diagnostics socket;
- K_Line, L_Line – PINs of OBD interface.

1.2. LEGAL NOTICE

Copyright © 2012 **Ruptela**. All rights reserved. Reproduction, transfer, distribution or storage of parts or all of the contents in this document in any form without the prior written permission of Ruptela is prohibited. Other products and company names mentioned in this document are trademarks or trade names of their respective owners.

1.3. SAFETY REQUIREMENTS



All the associated (additional) equipment as PC, batteries, sensors and others, shall meet the requirements of standard EN60950-1.



Do not disassemble the terminal. If the enclosure of the terminal is damaged, or the insulation of wires is damaged, first of all unplug the 10 pins connector from the terminal carefully.



All of the wireless data transferring equipment produces interference that may affect other devices which are placed nearby.



The terminal can be installed or dismantled only by qualified personnel!



The terminal must be firmly fastened in the predefined location. Predefined location is explained in the mounting instructions.



The programming must be performed using a 2nd safety class of PCs (with autonomic power supply).



Be sure that the terminal is installed in a place where it cannot be reached by water drops and humidity.



Caution! There is a risk of explosion if the battery is replaced by an incorrect type. Dispose used batteries according to the instructions.



Any installation and/or handling during a lightning storm is prohibited.



Use cables provided with FM device.
Ruptela is not responsible for any harm caused by using wrong cables for PC <-> FM Terminal connection.



Attention! Do not connect the wires marked (+ battery) wrongly and (chassis) to battery poles. If poles are mixed, the device will break.



To disconnect the device from the power supply, you need to disconnect 10 PINs plug and connect to internal battery.

This chapter contains information on how to operate with the FM terminal safely. By following these requirements and recommendations, you will avoid dangerous situations. You must read these instructions carefully and follow them strictly before operating the device! The terminal is supplied from a car battery with these ratings: 12/24V $\overline{=}$ 1A/500mA. The allowed voltage range for the battery is: 10...32V DC.

To avoid mechanical damage, it is advised to transport the FM terminal in an impact-proof package.

Before connecting the wires with 14 PINs plug to the vehicle, ensure that 10 PINs plug is disconnected from the terminal. Be sure that cross-sectional area of wires mounting is at least 0.75 mm².

To dismount terminal correctly from the vehicle, first of all disconnect 10 PINs plug and only then other plugs or interfaces can be disconnected.

Always connect 14 PINs plug before connecting 10 PINs plug.

The terminal is intended to be installed in a restricted access location, which is not accessible for the operator. The terminal is not intended to be used for boats.

FM-Pro3

2. FM-PRO3

2.1. BASIC DESCRIPTION

FM-Pro3 is a terminal with GPS/GLONASS / GSM connectivity, which is able to determine the object's coordinates and transfer them via the GSM network. This terminal is perfectly suitable for applications where location acquirment of remote objects is needed. It is important to mention that FM-Pro3 has additional inputs and outputs, which let control and monitor other remote objects. 1-Wire® interface (for Dallas Digital Thermometer or I-Button Reader) and CAN-bus interface are integrated (for data acquisition of trucks FMS data interface). It also has 2 simplified RS232 ports and one RS485 to connect additional equipment such as Personal Navigation Device, digital fuel level sensor or other (special firmware is required for this).

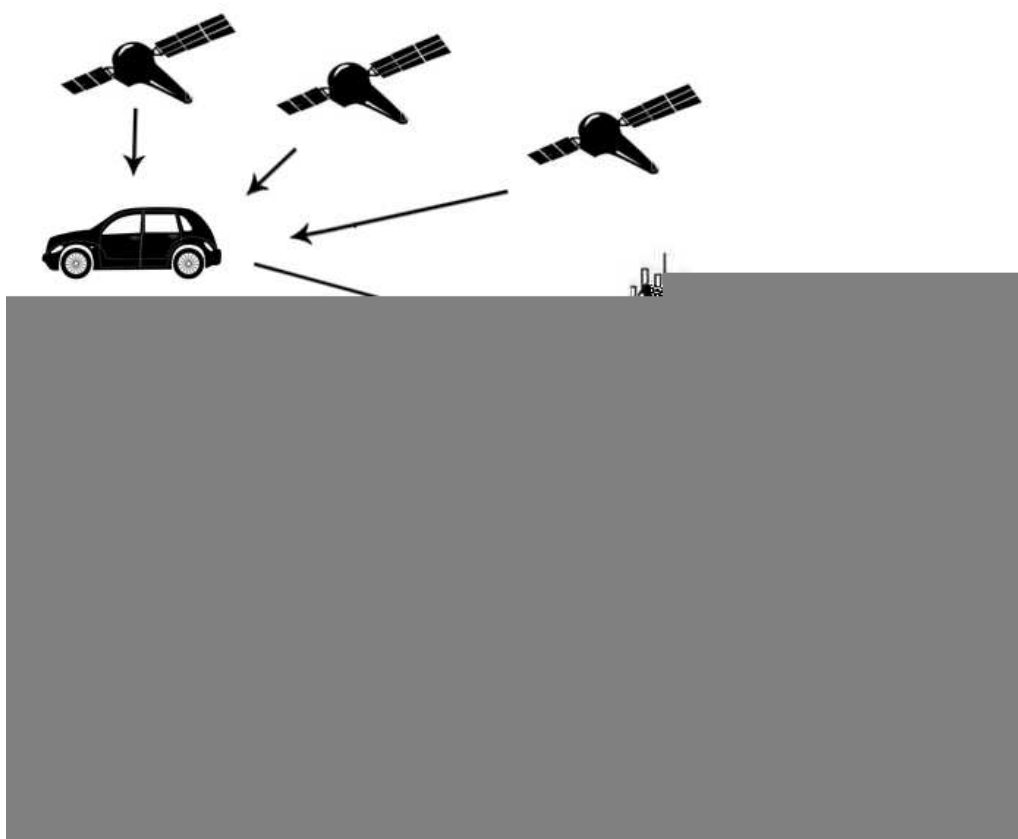

Figure1. Example of application of GPS/GLONASS/GSM terminal FM-Pro3 for controlling and monitoring of remote objects.

2.2. BASIC DESCRIPTION



Figure2. FM Pro3 device, power and I/O cables and GPS/GLONASS antenna.

The FM-Pro3 device is supplied to the customer in a cardboard box containing all the equipment that is necessary for operation. The package contains:

- The FM-Pro3 device;
- 10 PIN plug with wires for power supply and I/O connection;
- Magnetic GPS/GLONASS antenna with sticker;
- 14 PIN plug with wires for CAN-bus, 1-Wire, 2 simplified RS232, RS485 and K_line, L_line connection.

2.3. ADDITIONAL ACCESSORIES

There are a few standard accessories available for FM-Pro3 that are not included in the package:

- Analog Temperature sensor;
- 1-Wire Digital Temperature Sensor DS18B20 / DS18S20;
- I-Button.

Note: *the manufacturer does not supply a SIM card in the package, which is necessary for connection to the GSM network! SIM card can be obtained from your local GSM service provider! SIM card can work with the Terminal only when all SIM card security codes are disabled!*

If any of the components are not in the package, please contact the manufacturer's representative or the vendor (www.ruptela.com).

FM-Pro3

2.4. BASIC CHARACTERISTICS

Inputs / Outputs:

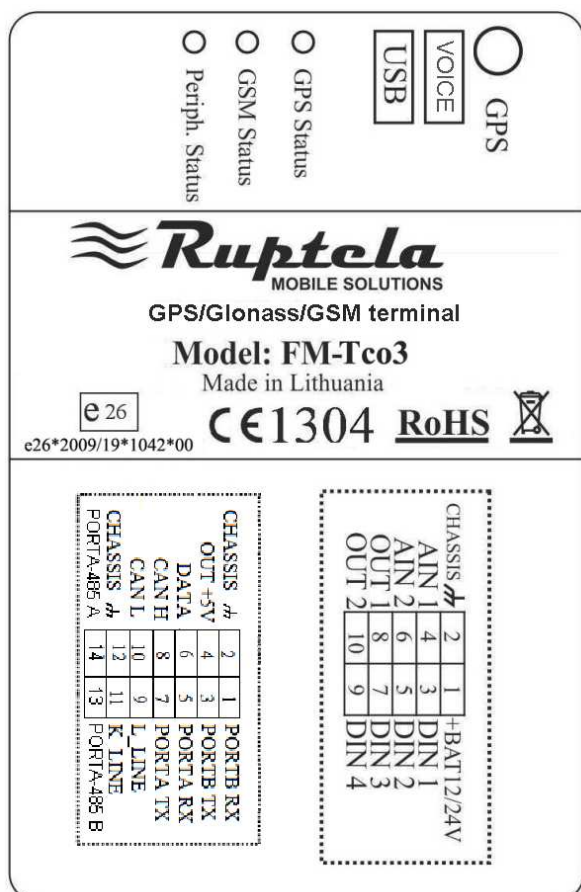

IO1 – 10 pin (2x5 plug):

CHASSIS #	2	1	+BAT 12/24V
AIN 1	4	3	DIN 1
AIN 2	6	5	DIN 2
OUT 1	8	7	DIN 3
OUT 2	10	9	DIN 4

IO2 – 14 pin (2x7 plug):

CHASSIS #	2	1	PORTB RX
OUT +5V	4	3	PORTB TX
DATA	6	5	PORTA RX
CAN H	8	7	PORTA TX
CAN L	10	9	L_LINE
CHASSIS #	12	11	K LINE
PORTA-485 A	14	13	PORTA-485 B

Paired connection scheme:

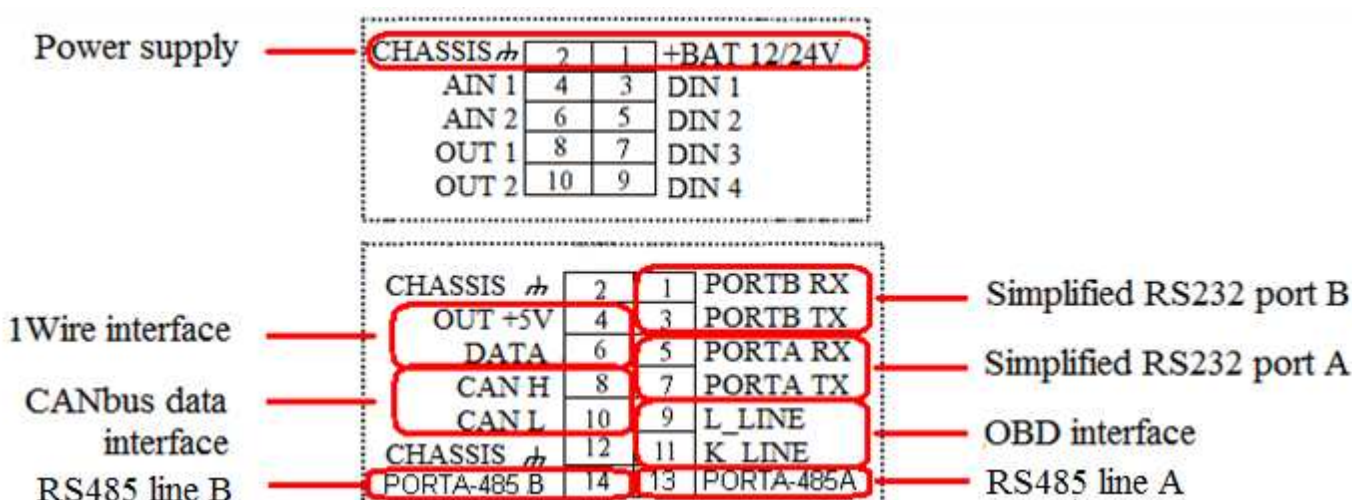

Other Inputs / Outputs are not paired. Also two spare Chassis pins can be paired with any I/O, they are only for easier mounting.

2.5. TECHNICAL FEATURES

Power supply	External Battery Ratings: +12/24V  1A/500mA Internal battery Ratings: Li-Po 3.7V 680 mAh (up to 3 hours)	GPS	Ublox module (with external GPS/GLONASS antenna)
Fuses	External fuse (mounted into +BAT wire): F 2AL Internal fuse (mounted into internal battery module): SMD 2A	GPRS/GSM	Simcom module (with internal GSM antenna)
Dimensions	111.25 x 75 x 25.2 mm	Accelerometer	LIS3DH accelerometer
Weight	140g	LED's	GPS fix LED, GSM LED, Peripheral LED, All LED's are green.
Temperatures	Operational temp.: -35°C ... +55°C Storage temp.: -40°C ... +65°C	Mini USB	Mini USB socket
TRRS connector	3,5 mm TRRS connector for handle speaker and microphone	SIM	SIM card holder with lock
Micro SD	Micro SD card holder	10 pin plug	For ex. Tyco multi-lock 4-794619-0 socket
		14 pin plug	For ex. Tyco multi-lock 4-794619-4 socket
		Housing / Material	UL94-HB Plastic case
		2x Simplified RS232 ports	PORTA Rx, Tx PORTB Rx, Tx
		RS485 port	PORTA – 485

FM-Pro3

2.6. FM PRO 3 DIMENSIONS

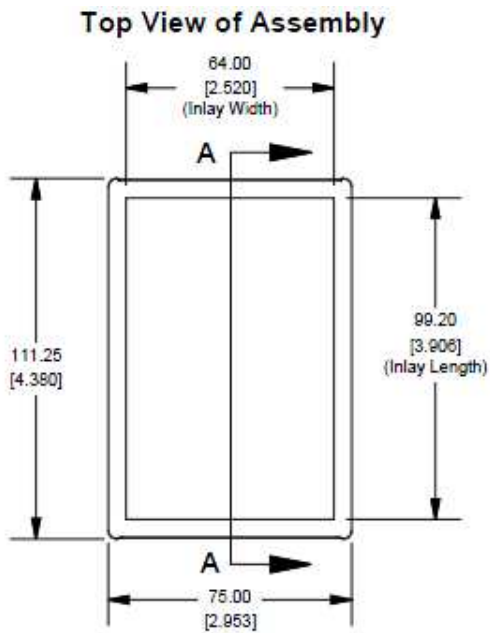

End View of Assembly

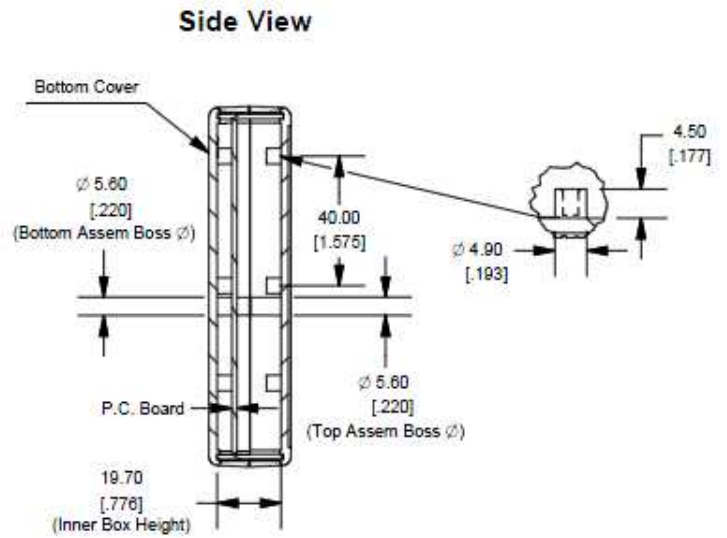
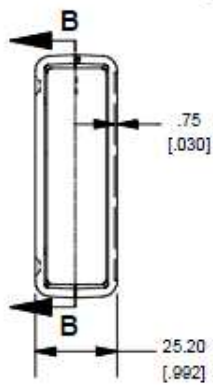

FM-Pro3

2.7. LED STATUSES

GPS LED

When GPS/GLONASS signal is not received or GPS/GLONASS signal is not accurate, the GPS LED is blinking as follows:

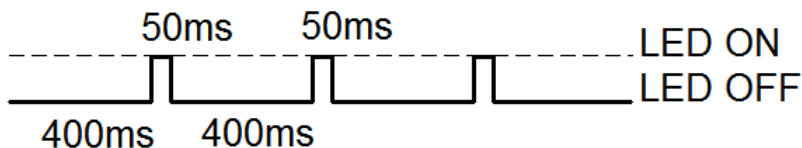

When accurate GPS/GLONASS signal is received, the GPS LED is blinking as follows:

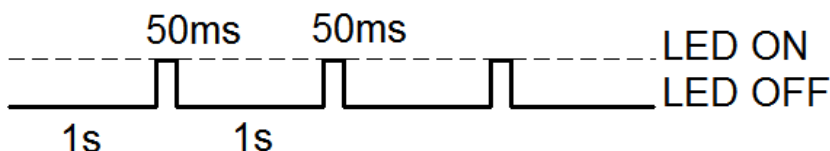

GSM LED

When GSM signal is not received, GSM LED is blinking as follows:

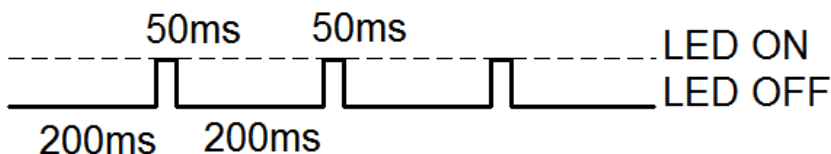

When device has a good GSM signal, but no GPRS, LED is blinking as follows:

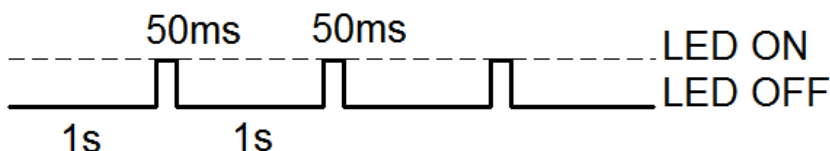

When device has good GSM signal and it is connected to GPRS, then LED is blinking as follows:

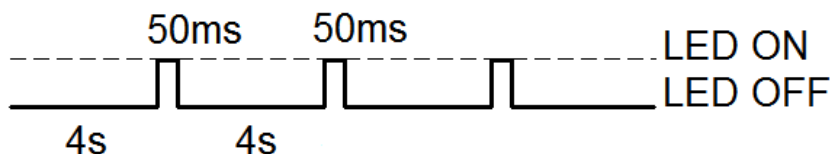

FM-Pro3

When the FM-Pro3 terminal has GSM signal and it is sending data via GPRS, LED is blinking:

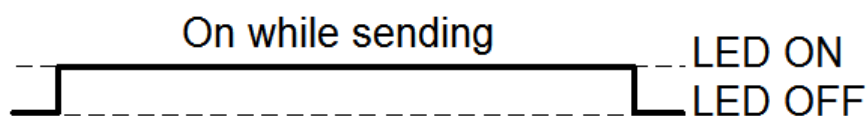

Peripheral LED

To the FM-Pro3 terminal can be attached up to three peripheral interfaces. So there are 3 different types of blinking when one or other peripheral is connected.

When there is no peripheral attached, LED will not blink at all:



When there is 1 out of 3 peripheral interfaces connected, the peripheral LED is blinking:

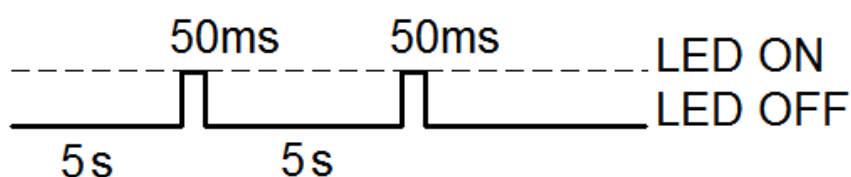

When there are 2 out of 3 peripheral interfaces connected, peripheral LED is blinking:

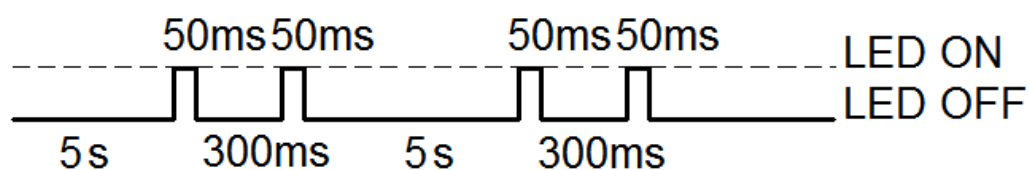

When there are 3 out of 3 peripheral interfaces connected, Peripheral LED is blinking:

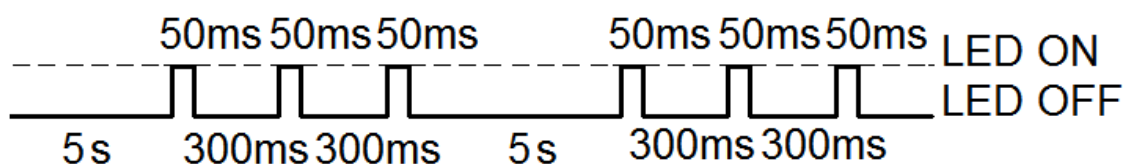

FM-Pro3

2.8. PINOUT CONNECTION, USB

FM-Pro3 standard plugs, 14 and 10 pins.

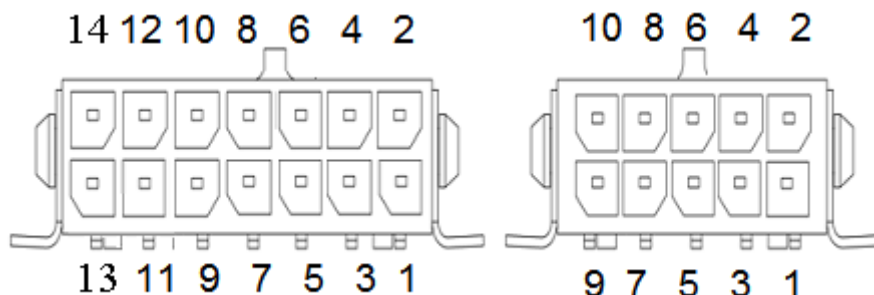

Standard FM-Pro3 14 PINs plug description:

Pin No.	Pin name	Description
1.	PortB RX	Port B receive signal
2.	Chassis ⚡	The frame or chassis of a car.
3.	PortB TX	Port B transit signal
4.	OUT +5V	+5V output for Dallas 1-Wire® devices (max 20 mA)
5.	PortA RX	Port A receive signal
6.	Data	Data channel for Dallas 1-Wire® devices
7.	PortA TX	Port A transit signal
8.	CAN H	SAE J1939 CAN interface High channel
9.	L_Line	SAE J1939 CAN interface L_Line channel, diagnostics
10.	CAN L	SAE J1939 CAN interface Low channel
11.	K_Line	SAE J1939 CAN interface K_Line channel, diagnostics
12.	Chassis ⚡	The frame or chassis of a car
13.	PORTA-485A	RS-485 differential signaling line A
14.	PORTA-485B	RS-485 differential signaling line B

TRRS connector is used for connecting speaker and microphone to FM device. Communication is half-duplex, so you can't listen and speak at the same time (you have to use a switch). To initialize a conversation - you need to call from your phone to SIM card number, which is inside the device. Device will automatically answer this call. More information about TRRS is stored in TRRS connector specification.

FM-Pro3

Standard FM-Pro3 10 PINs plug description:

Pin No.	Pin name	Description
1.	+BAT 12/24V	Battery rated voltage: 12/24V. Allowed battery voltage range: 10...32V
2.	Chassis $\#$	The frame or chassis of a car
3.	DIN 1	Digital input, channel 1(It can be also used as a pulse counter). Threshold 4V
4.	AIN 1	Analog input, channel 1. Input range: 0 – 30V
5.	DIN 2	Digital input, channel 2(It can be also used as a pulse counter). Threshold 4V
6.	AIN 2	Analog input, channel 2. Input range: 0 – 30V
7.	DIN 3	Digital input, channel 3. Threshold 4V
8.	OUT 1	Digital output. Channel 1. Open collector output. Max. 32V \Rightarrow 250 mA
9.	DIN 4	Digital input, channel 4. Threshold 4V
10.	OUT 2	Digital output. Channel 2. Open collector output. Max. 32V \Rightarrow 250 mA

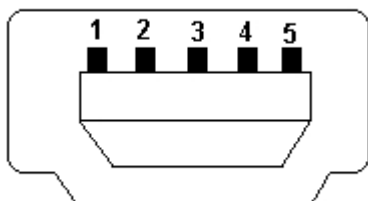

USB

Pin No.	Pin name	Description
1.	VBUS	Power
2.	D-	Data -
3.	D+	Data +
4.	ID	NC
5.	GND	Ground

2.9. SPECIAL FEATURES

- Any element event triggers (external sensor, input, speed, temperature, etc.);
- Smart profile switching (GSM operator or any element depended);
- Highly configurable data acquisition and sending;
- Real-time process monitoring;
- Authorized number list for remote access;
- Firmware update via GPRS or Mini USB port;
- Configuration update via GPRS, SMS or Mini USB port;
- TCP/IP or UDP/IP protocol support;
- 16 000 record storing (without micro SD card);
- Up to 32 GB micro SD card as Flash memory extension;
- Ability to connect speaker/ microphone (with switching capability) through 3,5 mm TRRS connector.

2.10. QUALIFICATION AND CERTIFICATION

The FM-Pro3 terminal complies the essential requirements detailed in the following Articles of the Directive:

Essential Requirements	Conformed Specifications / Standards
Safety R&TTE, Article 3.1(a)	EN 60950-1:2006+A11:2009
EMC R&TTE, Article 3.1(b)	EN 301 489-1 V1.6.1 EN 301 489-7 V1.3.1
Radio Spectrum R&TTE, Article 3.2	EN 301 511 (v9.0.2)
Environmental testing. Part 2-64. Tests – Test Fh: Vibration, broadband random and guidance (IEC 60068-2-64:2008)	LST EN 60068-2-64:2008

FM-Eco3

3. FM-ECO3

3.1. BASIC DESCRIPTION

FM-Eco3 is a terminal with GPS/GLONASS / GSM connectivity, which is able to determine the object's coordinates and transfer them via the GSM network. This terminal is perfectly suitable for applications where location acquisition of remote objects is needed. It is important to mention that FM-Eco3 has additional inputs and outputs, which let control and monitor other remote objects.

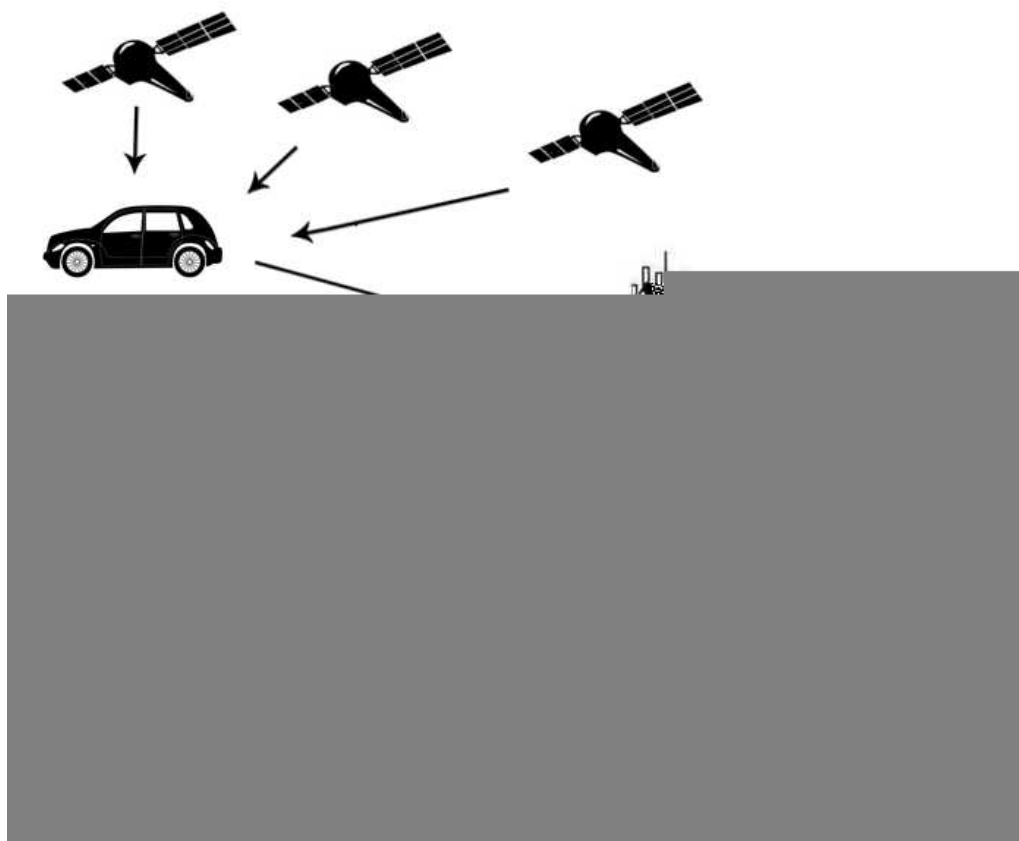

Figure1. Example of application of GPS/GLONASS/GSM terminal FM-Eco3 for controlling and monitoring of remote objects.

FM-Eco3

3.2. PACKAGE CONTENTS



Figure2. FM-Eco3 device, power and I/O cables and GPS/GLONASS antenna.

The FM-Eco3 terminal is supplied to the customer in a cardboard box containing all the equipment which is necessary for operation.

The package contains:

- The FM-Eco3 Terminal.
- 10 PIN plug with wires for power supply and I/O connection
- Magnetic GPS/GLONASS antenna with sticker.

3.3. ADDITIONAL ACCESSORIES

There are a few standard accessories available for FM-Eco3 that are not included in the package:

- Analog Temperature sensor

Note: *the manufacturer does not supply a SIM card in the package, which is necessary for connection to the GSM network! SIM card can be obtained from your local GSM service provider! SIM card can work with the terminal only when all SIM card security codes are disabled!*

If any of the components are not in the package, please contact the manufacturer's representative or the vendor (www.ruptela.com).

FM-Eco3

3.4. BASIC CHARACTERISTICS

Inputs / Outputs:

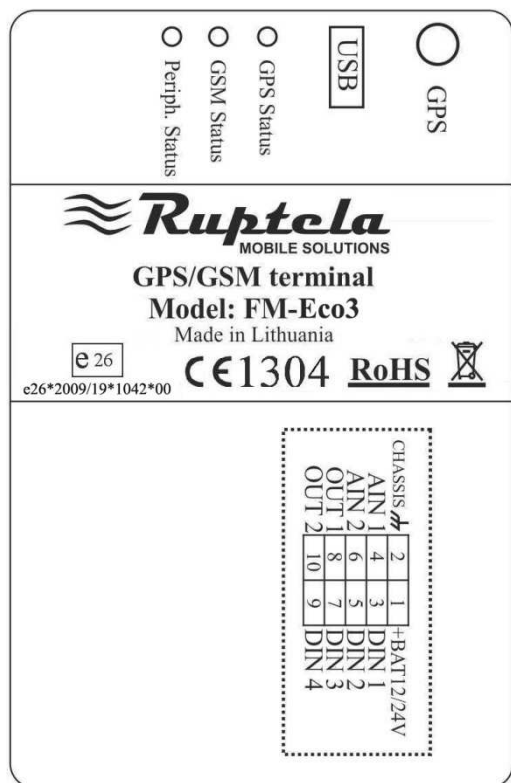

IO1 – 10 pin (2x5 plug):

CHASSIS #	2	1	+BAT 12/24V
AIN 1	4	3	DIN 1
AIN 2	6	5	DIN 2
OUT 1	8	7	DIN 3
OUT 2	10	9	DIN 4

Paired connection scheme:

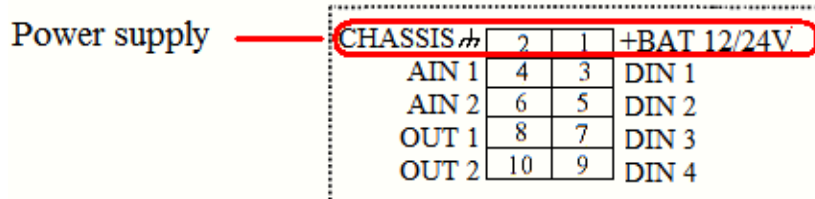

Other Inputs / Outputs are not paired.

FM-Eco3

3.5. TECHNICAL FEATURES

Power supply	External Battery Ratings: +12/24V  1A/500mA	GPS	Ublox module (with external GPS/GLONASS antenna)	
	Fuses	External fuse (mounted into +BAT wire): F 2AL	GPRS/GSM	Simcom module (with internal GSM antenna)
		Dimensions	111.25 x 75 x 25.2 mm	Accelerometer
LED's	GPS fix LED, GSM LED, All LED's are green.			
Mini USB	Mini USB socket			
Weight	110g	SIM	SIM card holder with lock	
		10 pin plug	Tyco multi-lock 4-794619-0 socket	
Temperatures	Operational temp.: -35°C ... +55°C Storage temp.: -40°C ... +65°C	Housing / Material	UL94-HB Plastic case	

FM-Eco3

3.6. FM-ECO3 DIMENSIONS

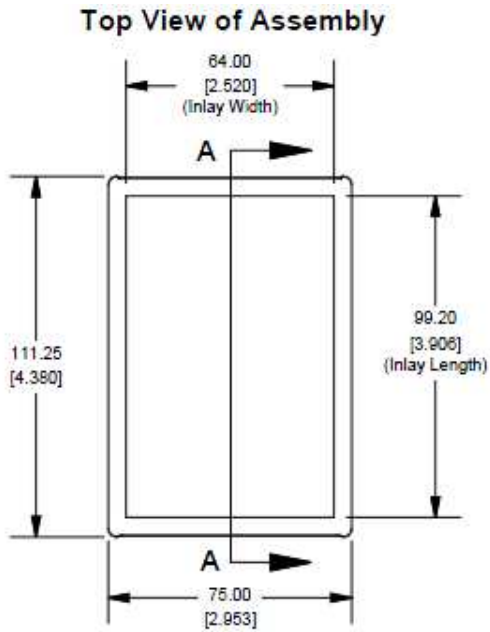

End View of Assembly

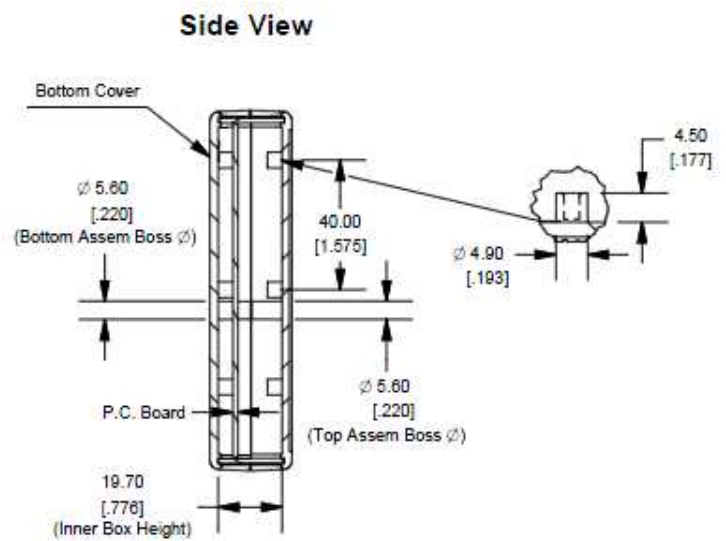
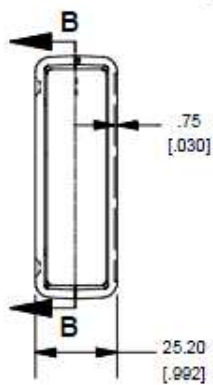

FM-Eco3

3.7. LED STATUSES

GPS LED

When GPS/GLONASS signal is not received or GPS/GLONASS signal is not accurate, the GPS LED is blinking as follows:

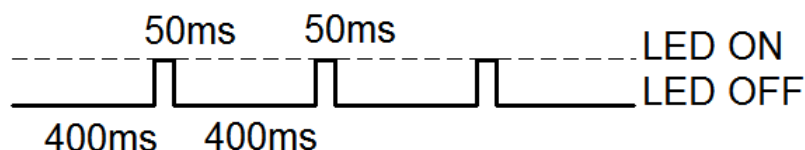

When accurate GPS/GLONASS signal is received, the GPS LED is blinking as follows:

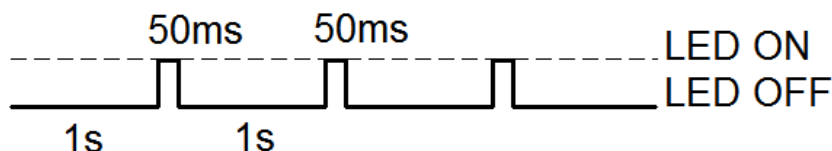

GSM LED

When GSM signal is not received, GSM LED is blinking:

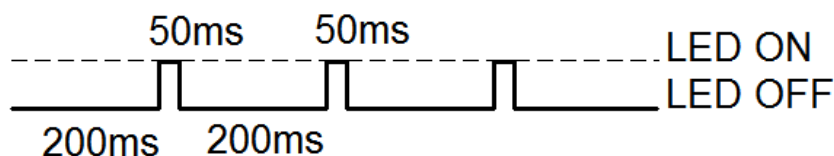

When device has good GSM signal, but no GPRS, LED is blinking:

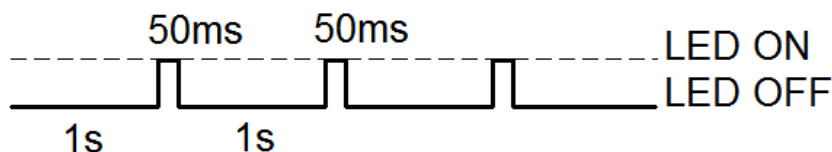

When device has good GSM signal and it is connected to GPRS, then LED is blinking:

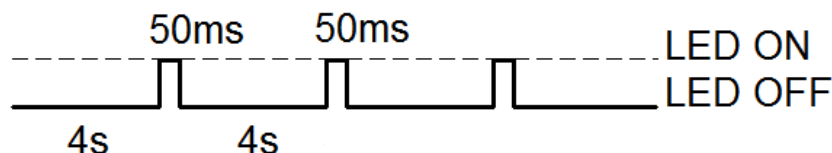

When the FM-Eco3 terminal has GSM signal and it is sending data via GPRS, LED is blinking:

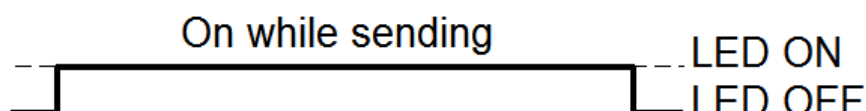

FM-Eco3

3.8. PINOUT CONNECTION, USB

FM-Eco3 standard 10 PINs plug.

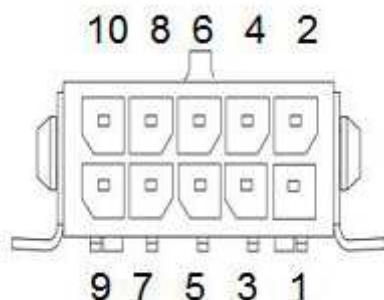

Standard FM-Eco3 10 PINs plug description:

Pin No.	Pin name	Description
1.	+BAT 12/24V	Battery rated voltage: 12/24V. Allowed battery voltage range: 10...32V
2.	Chassis $\#$	The frame or chassis of a car
3.	DIN 1	Digital input, channel 1. Threshold 4V
4.	AIN 1	Analog input, channel 1. Input range: 0 – 30V
5.	DIN 2	Digital input, channel 2. Threshold 4V
6.	AIN 2	Analog input, channel 2. Input range: 0 – 30V
7.	DIN 3	Digital input, channel 3. Threshold 4V
8.	OUT 1	Digital output. Channel 1. Open collector output. Max. 32V $\overline{=}$ 250 mA
9.	DIN 4	Digital input, channel 4. Threshold 4V
10.	OUT 2	Digital output. Channel 2. Open collector output. Max. 32V $\overline{=}$ 250 mA

USB

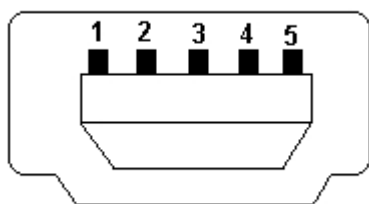

Pin No.	Pin name	Description
1.	VBUS	Power
2.	D-	Data -
3.	D+	Data +
4.	ID	NC
5.	GND	Ground

3.9. SPECIAL FEATURES

- Any element event triggers (external sensor, input, speed, temperature, etc.);
- Smart profile switching (GSM operator or any element depended);
- Highly configurable data acquisition and sending;
- Real-time process monitoring;
- Authorized number list for remote access;
- Firmware update via GPRS or Mini USB port;
- Configuration update via GPRS, SMS or Mini USB port;
- TCP/IP or UDP/IP protocol support;
- 16 000 record storing.

3.10. QUALIFICATION AND CERTIFICATION

The FM-Eco3 terminal complies the essential requirements detailed in the following Articles of the Directive:

Essential Requirements	Conformed Specifications / Standards
Safety R&TTE, Article 3.1(a)	EN 60950-1:2006+A11:2009
EMC R&TTE, Article 3.1(b)	EN 301 489-1 V1.6.1 EN 301 489-7 V1.3.1
Radio Spectrum R&TTE, Article 3.2	EN 301 511 (v9.0.2)
Environmental testing. Part 2-64. Tests – Test Fh: Vibration, broadband random and guidance (IEC 60068-2-64:2008)	LST EN 60068-2-64:2008

4. FM TCO3

4.1. BASIC DESCRIPTION

FM-Tco3 is a Terminal with GPS/GLONASS / GSM connectivity, which is able to determine the object's coordinates and transfer them via the GSM network. This terminal is perfectly suitable for applications where location acquirement of remote objects is needed. It is important to mention that FM-Tco3 has additional inputs and outputs, which let control and monitor other remote objects. 1-Wire® interface (for Dallas digital thermometer or I-Button reader) and CAN-bus interface integrated (for trucks FMS interface data acquisition). It also has 2 simplified RS232 ports for connecting additional equipments such as Personal Navigation Device, digital fuel level sensor or other (special firmware is needed for this).

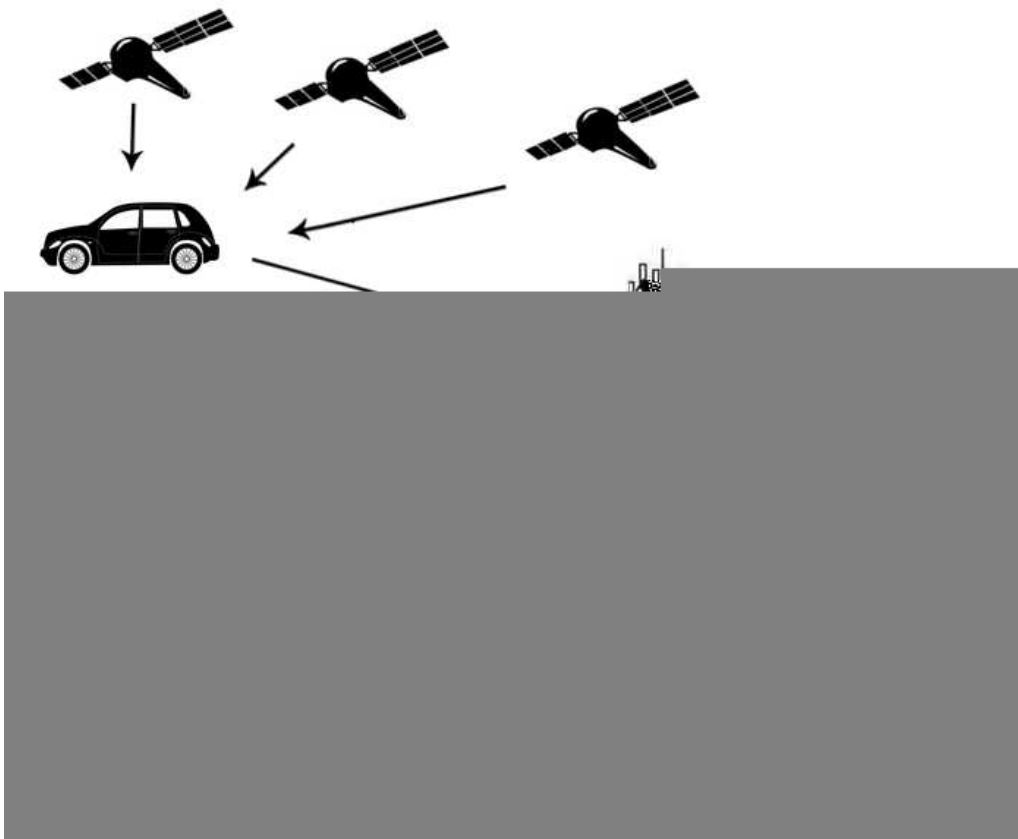

Figure1. Example of application of GPS/GLONASS/GSM terminal FM-Tco3 for controlling and monitoring of remote objects.

4.2. BASIC DESCRIPTION



Figure2. FM-Tco3 device, power and I/O cables and GPS/ GLONASS antenna.

The FM-Tco3 device is supplied to the customer in a cardboard box containing all the equipment that is necessary for operation. The package contains:

- The FM-Tco3 device.
- 10 PIN plug with wires for power supply and I/O connection
- Magnetic GPS/GLONASS antenna with sticker.
- 14 PIN plug with wires for CAN-bus, 1-Wire, 2 simplified RS232, RS485 and K_line, L_line connection.

4.3. ADDITIONAL ACCESSORIES

There are a few standard accessories available for FM-Tco3 that is not included in the package:

- Analog Temperature sensor;
- 1-Wire Digital Temperature Sensor DS18B20 / DS18S20;
- I-Button.

Note: *the manufacturer does not supply a SIM card in the package, which is necessary for connection to the GSM network! SIM card can be obtained from your local GSM service provider! SIM card can work with the Terminal only when all SIM card security codes are disabled!*

If any of the components are not in the package, please contact the manufacturer's representative or the vendor (www.ruptela.com).

FM-Tco3

4.4. BASIC CHARACTERISTICS

Inputs / Outputs:

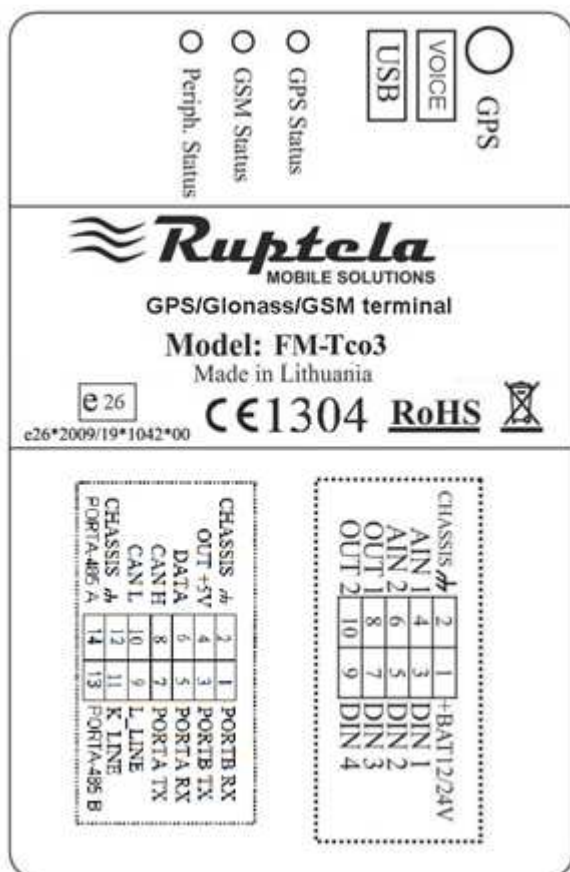

IO1 – 10 pin (2x5 plug):

CHASSIS #	2	1	+BAT 12/24V
AIN 1	4	3	DIN 1
AIN 2	6	5	DIN 2
OUT 1	8	7	DIN 3
OUT 2	10	9	DIN 4

IO2 – 14 pin (2x7 plug):

CHASSIS #	2	1	PORTB RX
OUT +5V	4	3	PORTB TX
DATA	6	5	PORTA RX
CAN H	8	7	PORTA TX
CAN L	10	9	L_LINE
CHASSIS #	12	11	K_LINE
PORTA-485 A	14	13	PORTA-485 B

Paired connection scheme:

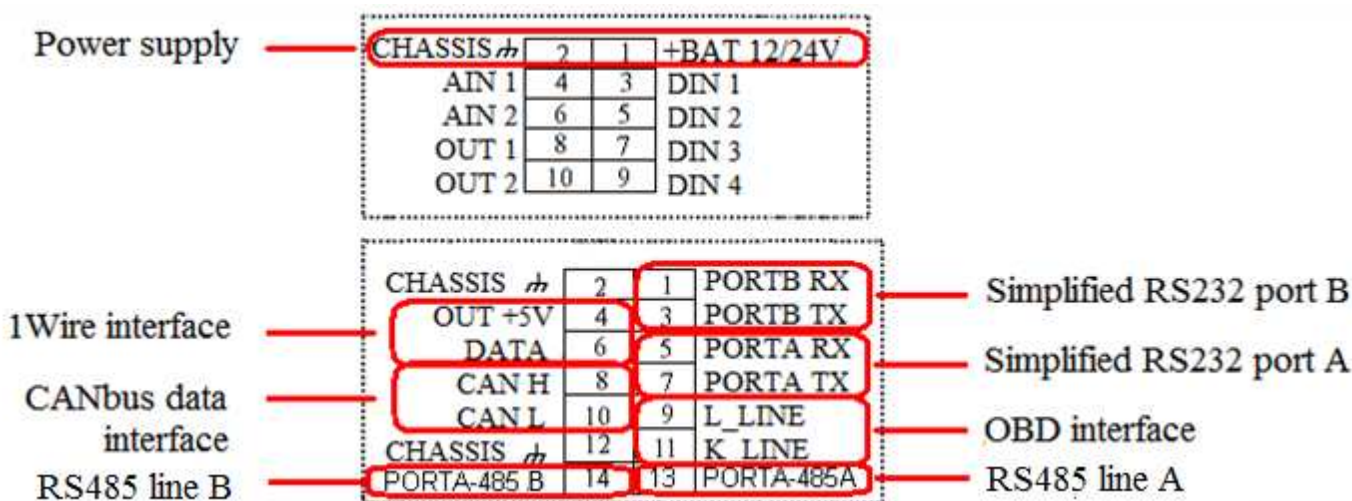

Other Inputs / Outputs are not paired. Also two spare Chassis pins can be paired with any I/O, they are only for easier mounting.

4.5. TECHNICAL FEATURES

Power supply	External Battery Ratings: +12/24V  1A/500mA Internal battery Ratings: Li-Po 3.7V 680 mAh (up to 3 hours)	GPS	Ublox module (with external GPS/GLONASS antenna)
Fuses	External fuse (mounted into +BAT wire): F 2AL Internal fuse (mounted into internal battery module): SMD 2A	GPRS/GSM	Simcom module (with internal GSM antenna)
Dimensions	111.25 x 75 x 25.2 mm	Accelerometer	LIS3DH accelerometer
Weight	140g	LED's	GPS fix LED, GSM LED, Peripheral LED, All LED's are green.
Temperatures	Operational temp.: -35°C ... +55°C Storage temp.: -40°C ... +65°C	Mini USB	Mini USB socket
Micro SD	Micro SD card holder	SIM	Sim card holder with lock
RS485 port	PORTA – 485	10 pin plug	For ex. Tyco multi-lock 4-794619-0 socket
		14 pin plug	For ex. Tyco multi-lock 4-794619-4 socket
		Housing / Material	UL94-HB Plastic case
		2x Simplified RS232 ports	PORTA Rx, Tx PORTB Rx, Tx
		TRRS connector	3,5 mm TRRS connector for handle speaker and microphone

FM-Tco3

4.6. FM-TCO3 DIMENSIONS

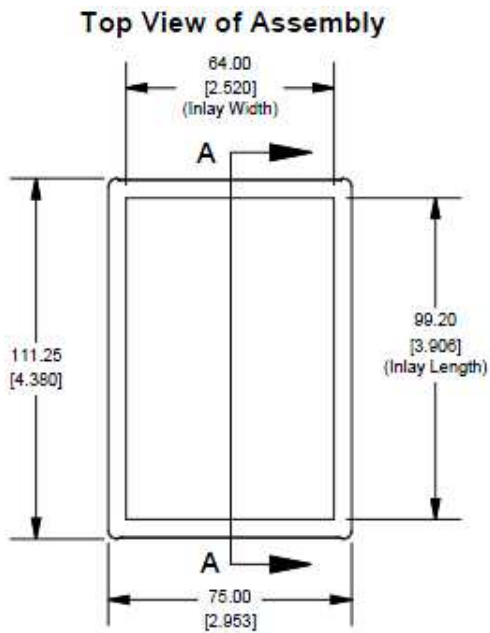

End View of Assembly

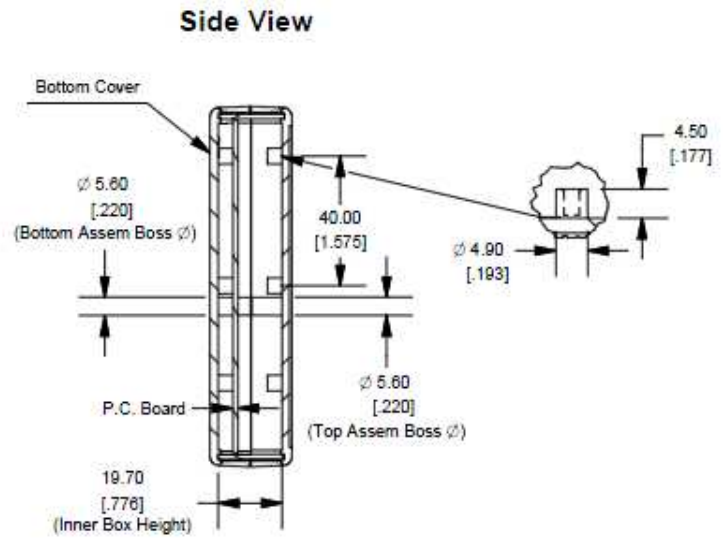
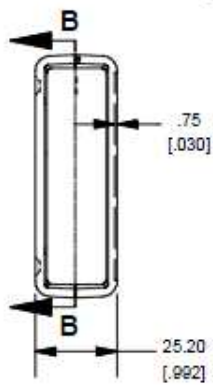

FM-Tco3

4.7. LED STATUSES

GPS LED

When GPS/GLONASS signal is not received or GPS/GLONASS signal is not accurate, the GPS LED is blinking as follows:

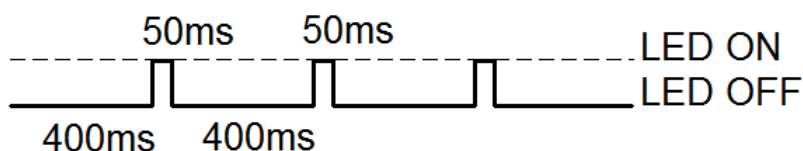

When accurate GPS/GLONASS signal is received, the GPS LED is blinking as follows:

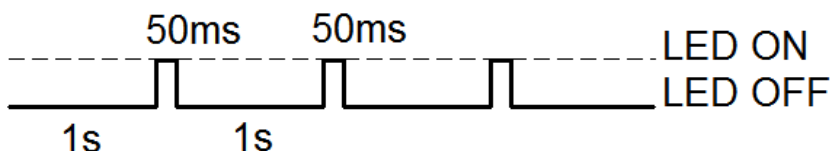

GSM LED

When GSM signal is not received, GSM LED is blinking as follows:

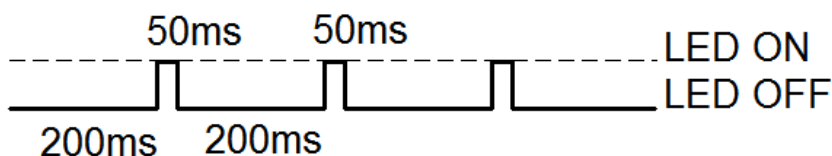

When device has a good GSM signal, but no GPRS, LED is blinking as follows:

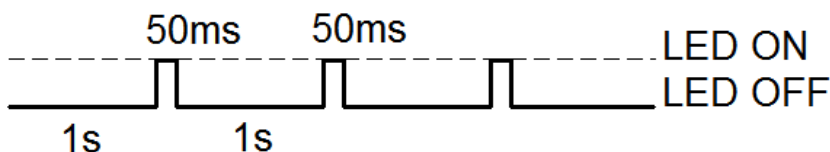

When device has good GSM signal and it is connected to GPRS, then LED is blinking as follows:

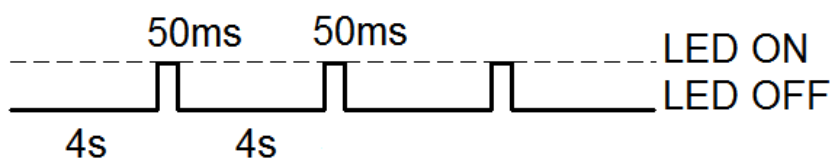

FM-Tco3

When the FM-Tco3 terminal has GSM signal and it is sending data via GPRS, LED is blinking:

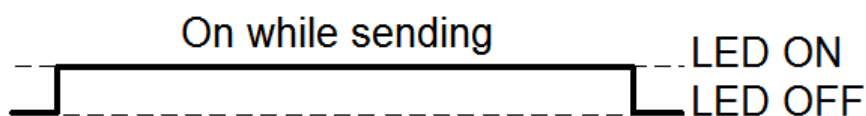

Peripheral LED

To the FM-Tco3 terminal there can be up to three peripheral interfaces attached. So there are 3 different types of blinking when one or other peripheral is connected.

When there is no peripheral attached, LED will not blink at all:



When there is 1 out of 3 peripheral interfaces connected, Peripheral LED is blinking:

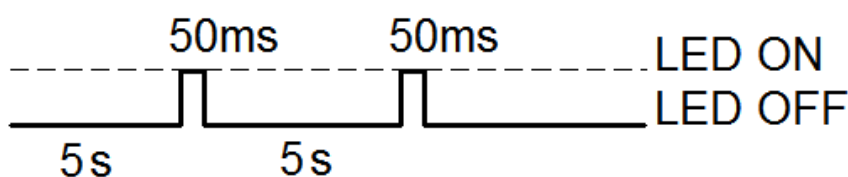

When there are 2 out of 3 peripheral interfaces connected, Peripheral LED is blinking:

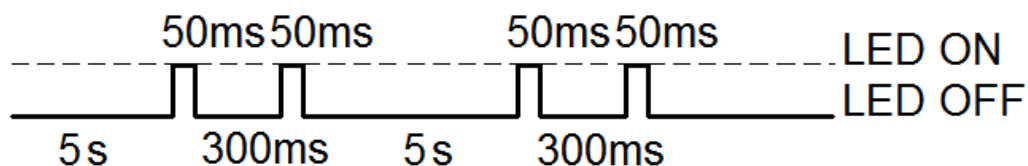

When there are 3 out of 3 peripheral interfaces connected, Peripheral LED is blinking:

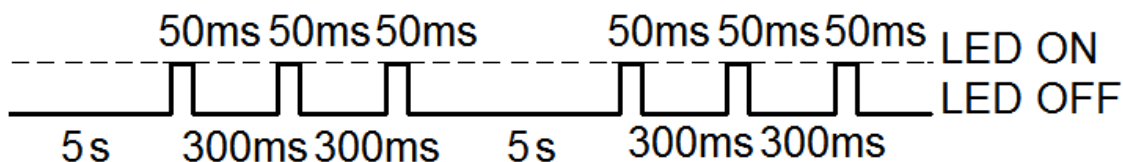

FM-Tco3

4.8. PINOUT CONNECTION, USB

FM-Tco3 standard plugs, 14 and 10 PINs.

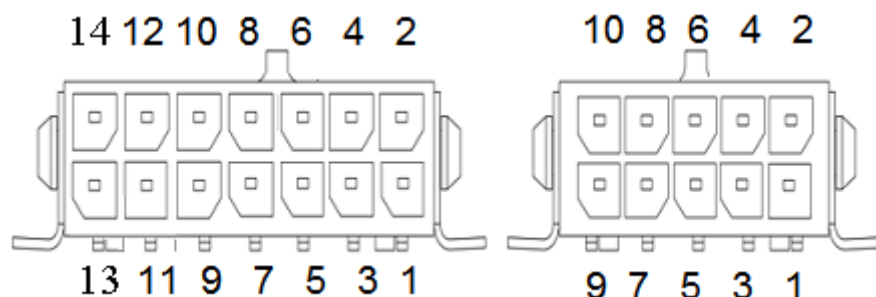

Standard FM-Tco3 14 PINs plug description:

Pin No.	Pin name	Description
1.	PortB RX	Port B receive signal
2.	Chassis ⚡	The frame or chassis of a car.
3.	PortB TX	Port B transit signal
4.	OUT +5V	+5V output for Dallas 1-Wire® devices (max 20 mA)
5.	PortA RX	Port A receive signal
6.	Data	Data channel for Dallas 1-Wire® devices
7.	PortA TX	Port A transit signal
8.	CAN H	SAE J1939 CAN interface High channel
9.	L_Line	SAE J1939 CAN interface L_Line channel, diagnostics
10.	CAN L	SAE J1939 CAN interface Low channel
11.	K_Line	SAE J1939 CAN interface K_Line channel, diagnostics
12.	Chassis ⚡	The frame or chassis of a car
13.	PORTA-485A	RS-485 differential signaling line A
14.	PORTA-485B	RS-485 differential signaling line B

TRRS connector is used for connecting speaker and microphone to FM device. Communication is half-duplex, so you can't listen and speak at the same time (you have to use a switch). To initialize a conversation - you need to call from your phone to SIM card number, which is inside the device. Device will automatically answer this call. More information about TRRS is stored in TRRS connector specification.

FM-Tco3

Standard FM-Tco3 10 PINs plug description:

Pin No.	Pin name	Description
1.	+BAT 12/24V	Battery rated voltage: 12/24V. Allowed battery voltage range: 10...32V
2.	Chassis \rightarrow	The frame or chassis of a car
3.	DIN 1	Digital input, channel 1(It can be also used as a pulse counter). Threshold 4V
4.	AIN 1	Analog input, channel 1. Input range: 0 – 30V
5.	DIN 2	Digital input, channel 2(It can be also used as a pulse counter). Threshold 4V
6.	AIN 2	Analog input, channel 2. Input range: 0 – 30V
7.	DIN 3	Digital input, channel 3. Threshold 4V
8.	OUT 1	Digital output. Channel 1. Open collector output. Max. 32V \rightarrow 250 mA
9.	DIN 4	Digital input, channel 4. Threshold 4V
10.	OUT 2	Digital output. Channel 2. Open collector output. Max. 32V \rightarrow 250 mA

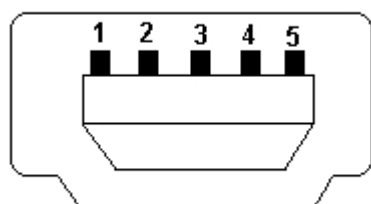

USB

Pin No.	Pin name	Description
1.	VBUS	Power
2.	D-	Data -
3.	D+	Data +
4.	ID	NC
5.	GND	Ground

4.9. SPECIAL FEATURES

- Any element event triggers (external sensor, input, speed, temperature, etc.);
- Smart profile switching (GSM operator or any element depended);
- Highly configurable data acquisition and sending (incl. data from tachograph*);
- Real-time process monitoring;
- Authorized number list for remote access;
- Firmware update via GPRS or Mini USB port;
- Configuration update via GPRS, SMS or Mini USB port;
- TCP/IP or UDP/IP protocol support;
- 16 000 record storing (without micro SD card).

- Up to 32 GB micro SD card as Flash memory extension.
- Ability to connect speaker/ microphone (with switching capability) through 3,5 mm TRRS connector.

* Data from tachograph: vehicle's VIN and registration numbers, driver's identification number, driver's state (Rest/Work/Drive/Available), driver card status (inserted/removed), total distance, trip distance, speed, RPM.

4.10. QUALIFICATION AND CERTIFICATION

The FM-Tco3 terminal complies the essential requirements detailed in the following Articles of the Directive:

Essential Requirements	Conformed Specifications / Standards
Safety R&TTE, Article 3.1(a)	EN 60950-1:2006+A11:2009
EMC R&TTE, Article 3.1(b)	EN 301 489-1 V1.6.1 EN 301 489-7 V1.3.1
Radio Spectrum R&TTE, Article 3.2	EN 301 511 (v9.0.2)
Environmental testing. Part 2-64. Tests – Test Fh: Vibration, broadband random and guidance (IEC 60068-2-64:2008)	LST EN 60068-2-64:2008

5. INSTALLATION AND CONFIGURATION INSTRUCTIONS

5.1. MODULE INSTALLATION

- Module should not be seen or easily reached.
- Module should be firmly fixed to the surface. **Please avoid mounting module near the metal surface or cables (see the picture below). Wrong module mounting may be the cause of module malfunction.**
- Module cannot be fixed to heat emitting or moving parts.
- SIM card should be inserted in the module while the connector is plugged off (while module has no power).
- Module must be fitted with double sided stick tape!

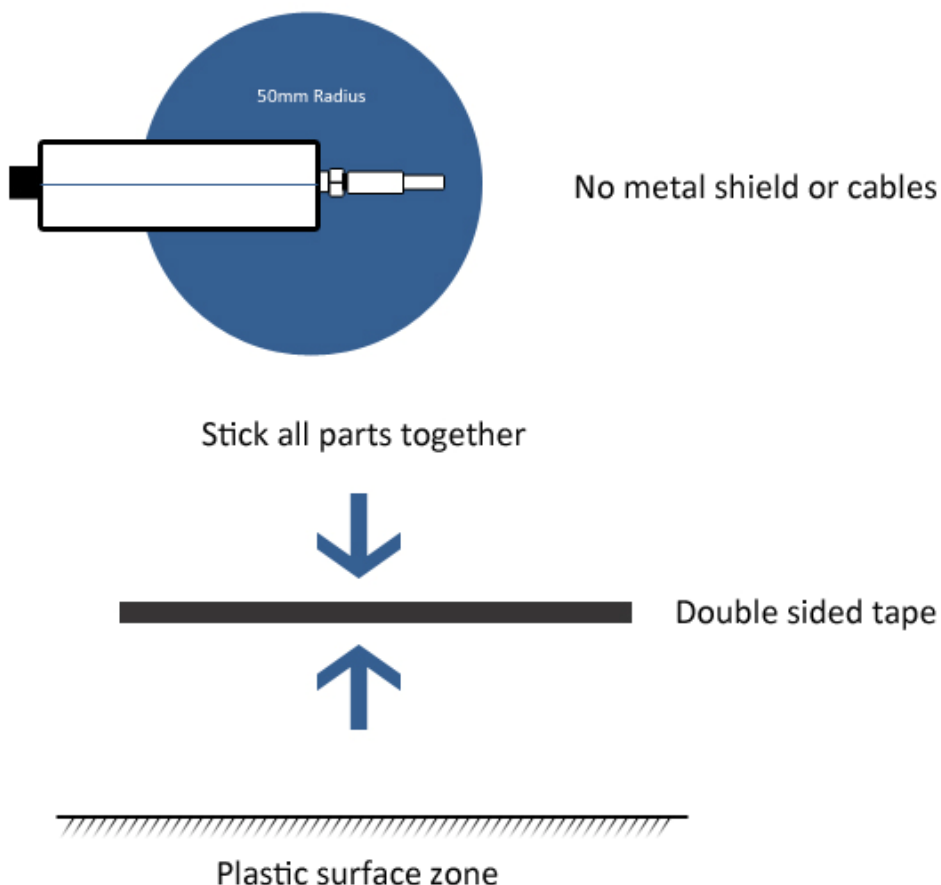

GPS/GLONASS antenna connection



CORRECT



INCORRECT

It is recommended to place GPS/GLONASS antenna behind the dashboard as close to the window as possible. A good example of GPS/GLONASS antenna placement is displayed in a picture below (area colored in blue).



5.2. DEVICE CONNECTION TO A PERSONAL COMPUTER

All examples of connection and configuration will be provided on a personal computer (PC) running Microsoft Windows XP SP3 32bit operating system. Usually identical or analogue procedures should be applied on newer versions of Windows family operating systems.

5.2.1.SYSTEM REQUIREMENTS

Hardware requirements:

- CPU: 1,5GHz or better.
- RAM: 512MB or more.
- USB port



Fig. 5.2.1.1 USB A to mini USB cable.

- USB A to mini USB cable (Fig.5.2.1.1)
 - Software requirements
- Operating system: Microsoft Windows XP, or Microsoft Windows Vista, or Microsoft Windows 7 (32-bit and 64-bit)
- Microsoft .NET framework 4 (available as a free download from <http://www.microsoft.com/downloads/en/details.aspx?FamilyID=9cfb2d51-5ff4-4491-b0e5-b386f32c0992>).

5.2.2.PREPARATION FOR CONNECTION

Before connecting FM Terminal to PC please check if you have the latest configuration software. You can download it from here: <ftp://dev.ruptela.lt> (user name:ftp, password: ftp).

At first connect device to +12/24V  1A/500mA power supply, this will prevent from damaging PC when FM device is active. You can use an AC/DC stabilized converter for this (not supplied with the device). When the device is powered up, it is safe to plug in USB cable.

5.2.3.DRIVER INSTALLATION

1. When the FM device is connected to PC for the first time, a notification should pop up that new hardware was found and configuration window is shown (Fig. 5.2.3.1). Select „No, not this time“, and click button „Next“.

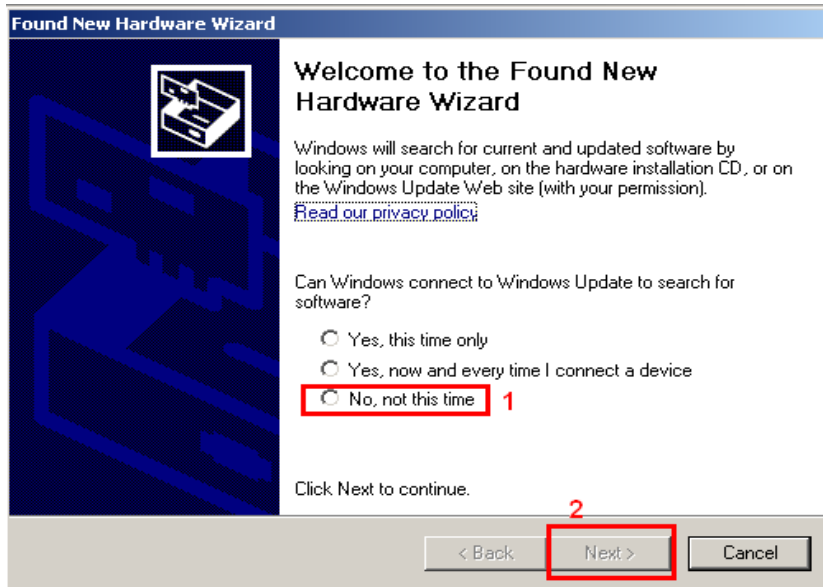

Fig. 5.2.3.1. Driver installation

2. In the next window select „Install from a list or specific location (Advanced)“ (Fig. 5.2.3.2.).

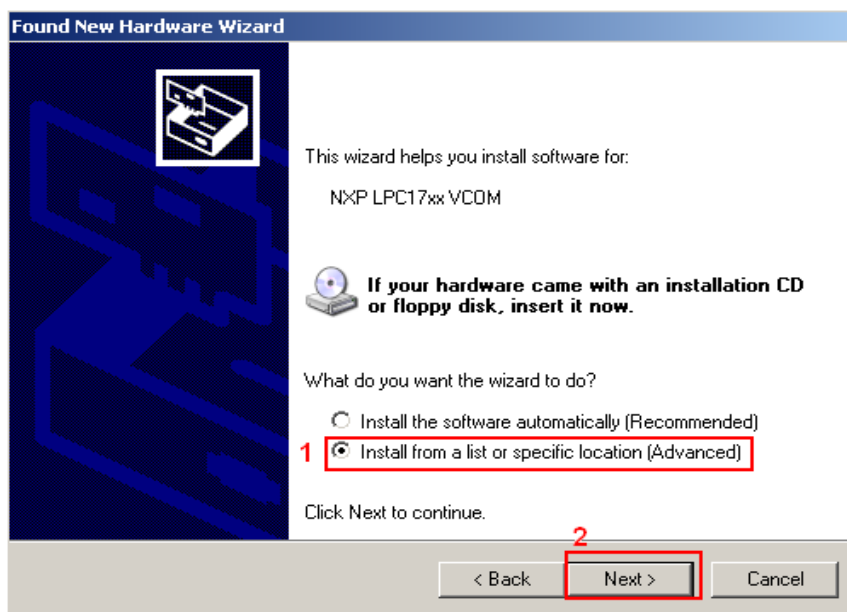

Fig. 5.2.3.2. Driver installation

3. In the next window select „Include this location in the search:“ and click „Browse“ and navigate to folder where configuration software is saved (i.e. *F:\FM3 configurator 00.01.15*) then click next(Fig. 5.2.3.3.).

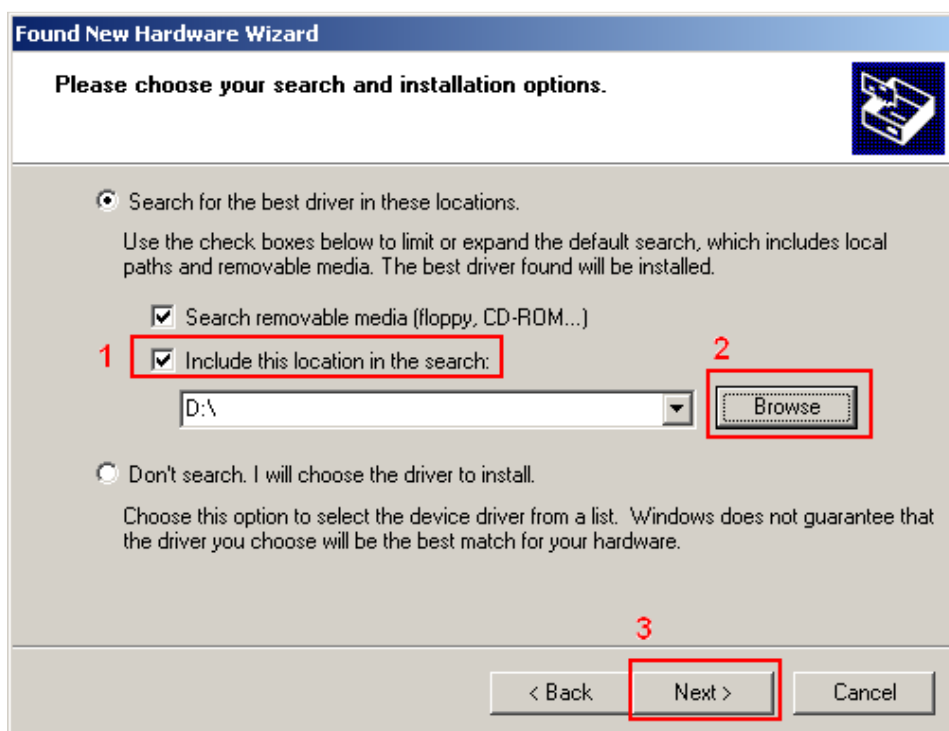

Fig. 5.2.3.3 Driver installation

4. Then driver installation should proceed. If asked, click „Continue Anyway“ (Fig. 5.2.3.4.).

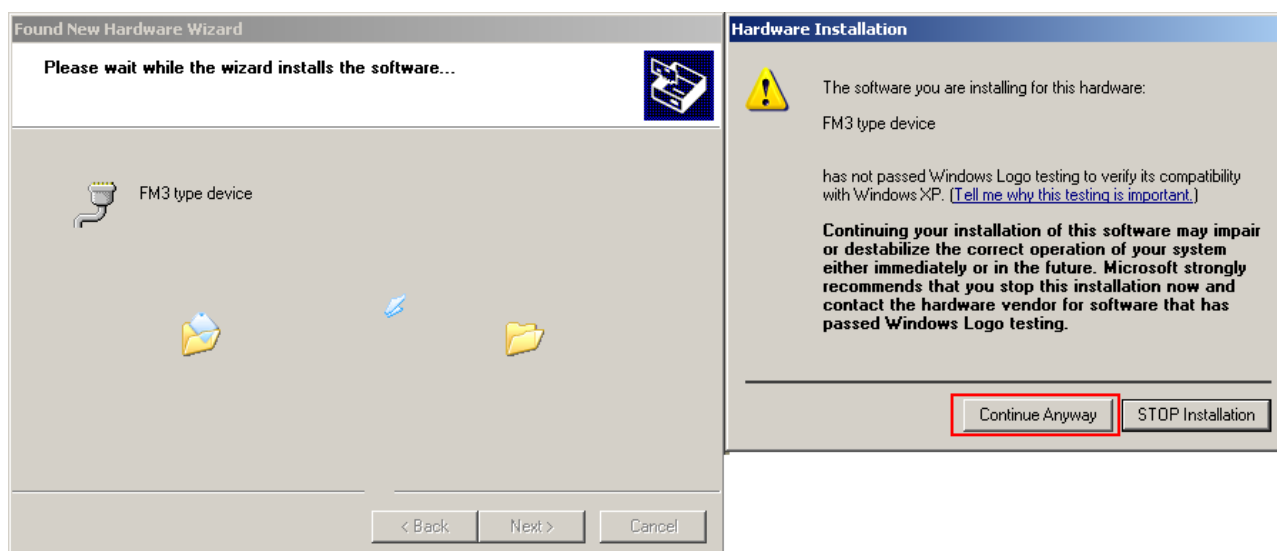

Fig. 5.2.3.4. Driver installation

5. The driver should be installed and work.

If an error pops up that PC „Cannot Start this hardware“ (Fig. 5.2.3.5.), you should restart the PC or do the following actions:

- 1) Click finish and go to „Device Manager“.
- 2) In device manager go to „Ports (COM & LPT)“,
- 3) Expand section then right-click on “FM type device (COMXX)”
- 4) Select “Disable” (Fig. 5.2.3.6.).
- 5) When asked for confirmation click “Yes”.
- 6) Then, again, right-click on “FM type device (COMXX)”
- 7) Select “Enable” (Fig. 5.2.3.7.).
- 8) Driver now should be completely installed and ready to use (Fig. 5.2.3.8.)

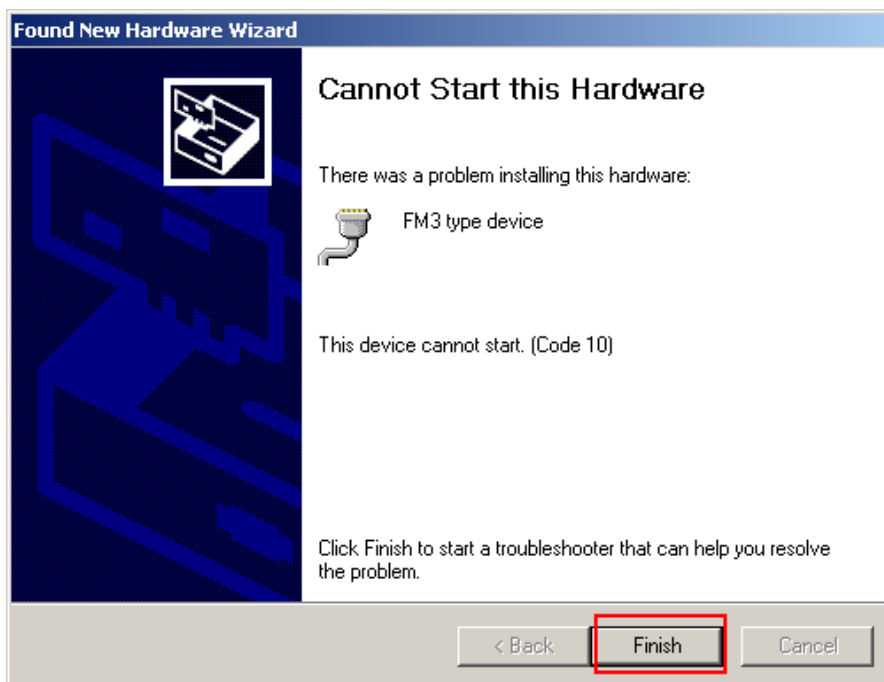

Fig. 5.2.3.5. Driver installation

FM Manual

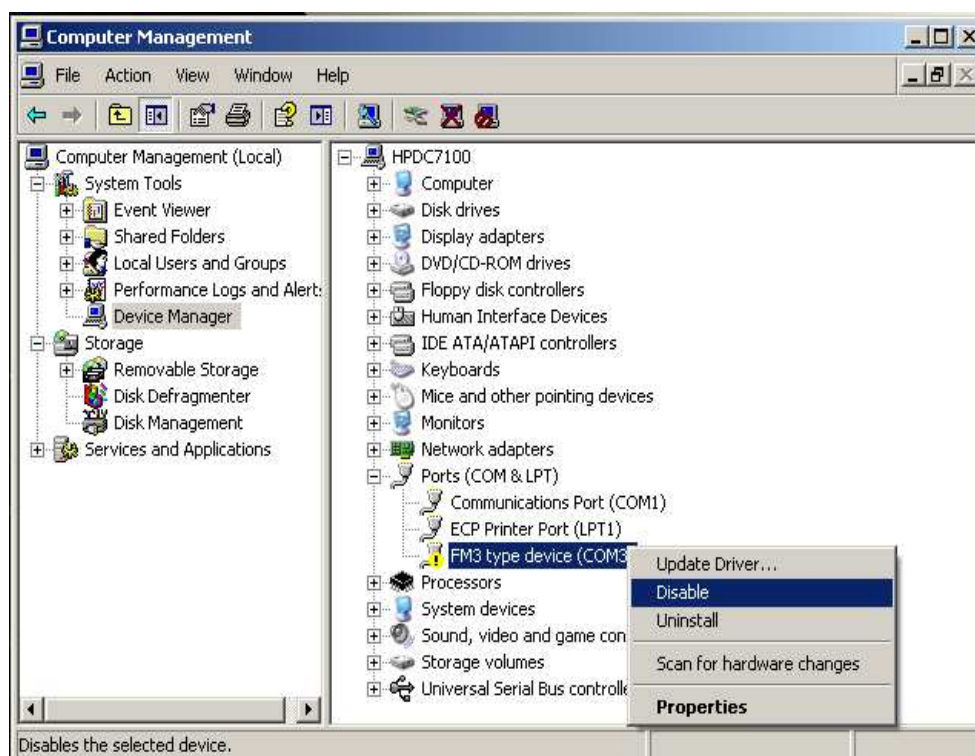

Fig. 5.2.3.6. Driver installation

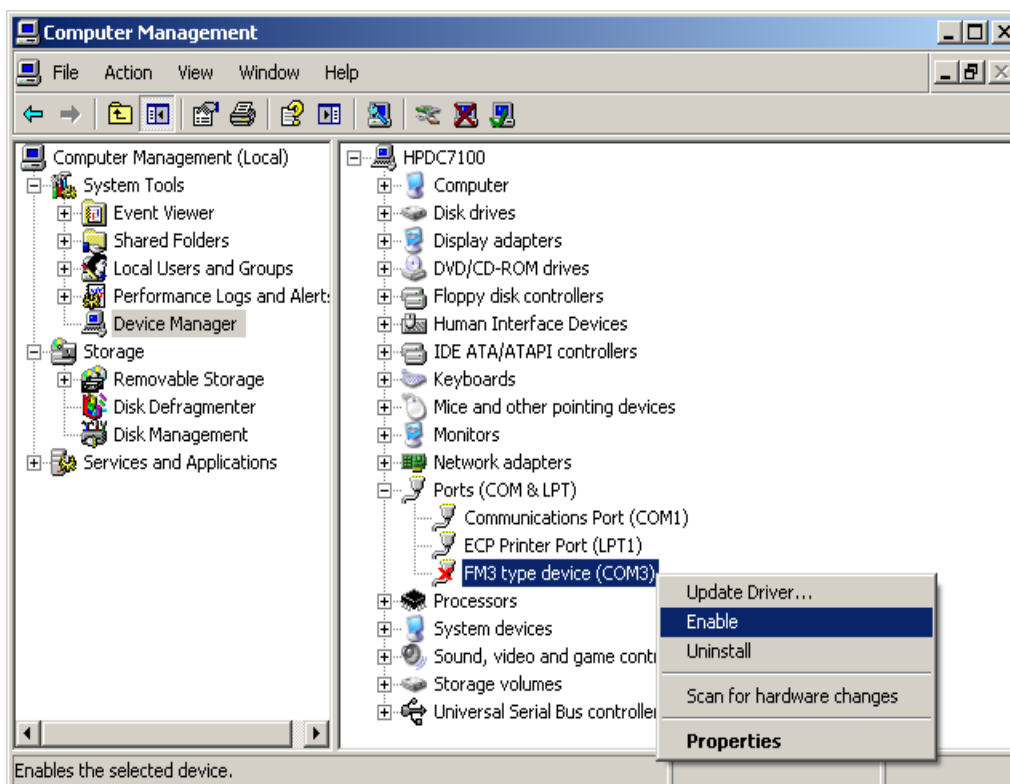

Fig. 5.2.3.7. Driver installation

FM Manual

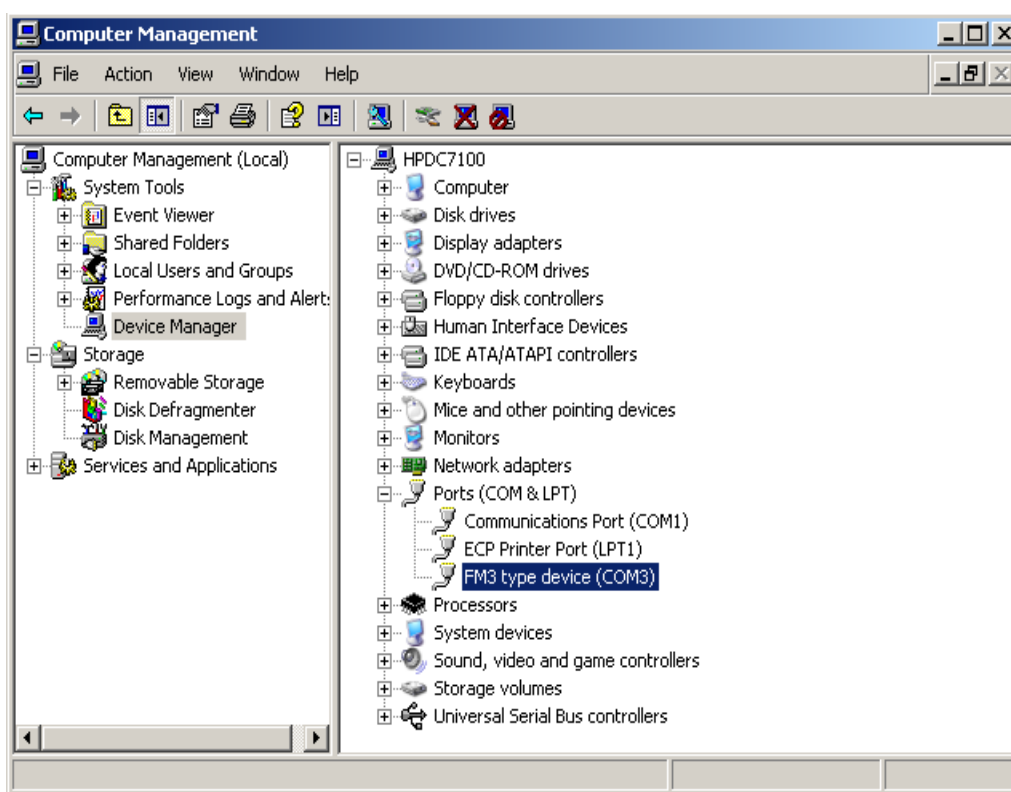

Fig. 5.2.3.8. Driver installation

5.3. CONFIGURATOR

In order to use configurator go to folder where you saved configuration software and launch „VCP.exe“ file. This configurator is intended to configure FM-Eco3, FM-Pro3 and FM-Tco3 devices.

5.3.1.INTERFACING TO COM PORT

In the main view upper left corner there is a drop box which contains COM ports list. You should select port corresponding to your device (you can check it in “Device manager”) and click “Connect” button. If connection is successful, “Connect” button changes into “Disconnect” and in the bottom of the main view there should be information available about software, hardware and IMEI number (Fig. 5.3.1.2.). Also while connected, the device type will be detected (Fig. 5.3.1.3.)



Fig. 5.3.1.1 COM port drop-box

FM Manual

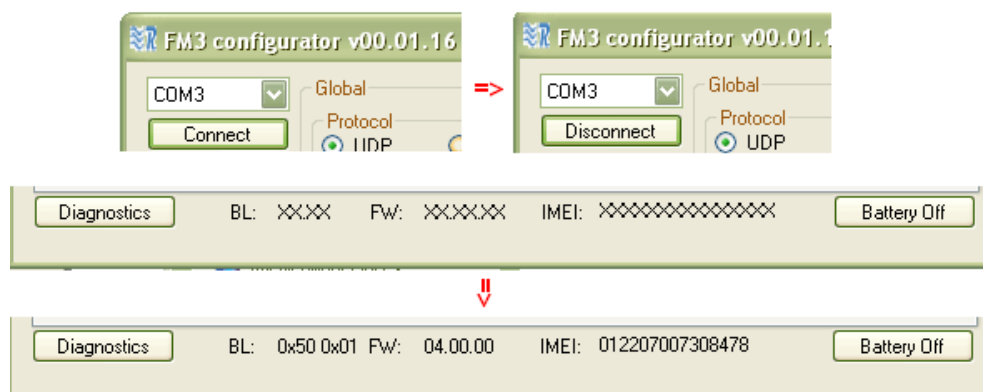

Fig. 5.3.1.2 Changes after connection to COM port

In order to disconnect click the “Disconnect” button. Sometimes when connected IMEI is displayed as a few unconditional characters, this means that device is not fully ready. Try to disconnect, wait half a minute or longer and connect again – this should fix the problem.

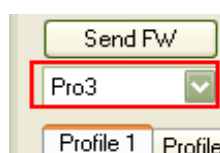

Fig. 5.3.1.3 Device type selection drop-box

If you want to enter Diagnostics tool, you need to click on COM port (i.e.) and then press Ctrl + Alt + D buttons. A new button “Diagnostics” will appear in the left bottom corner. You will need to connect to exact COM port there. After that you will be able to see:

- Voltage of analog inputs
- Voltage of internal battery and power supply
- Charge current
- Status of digital inputs
- Modem information
- GPS/GLONASS module information
- Digital outputs status (you will be able to change them)
- Modem temperature
- Loopback of different interfaces

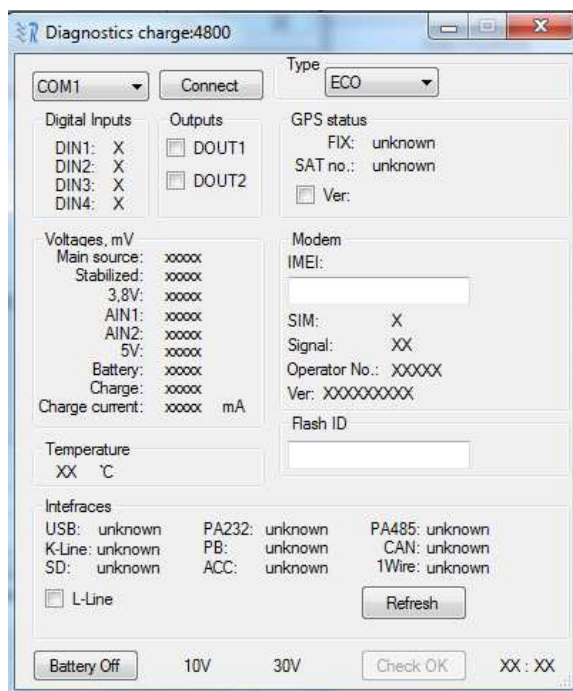

Fig. 5.3.1.4. Diagnostics function

5.3.2. GLOBAL PARAMETER CONFIGURATION

Global parameters are parameters which apply to the system in general. Global parameters are constant and do not change while the device is working, unless they are configured by user (Fig.5.3.2.1.).

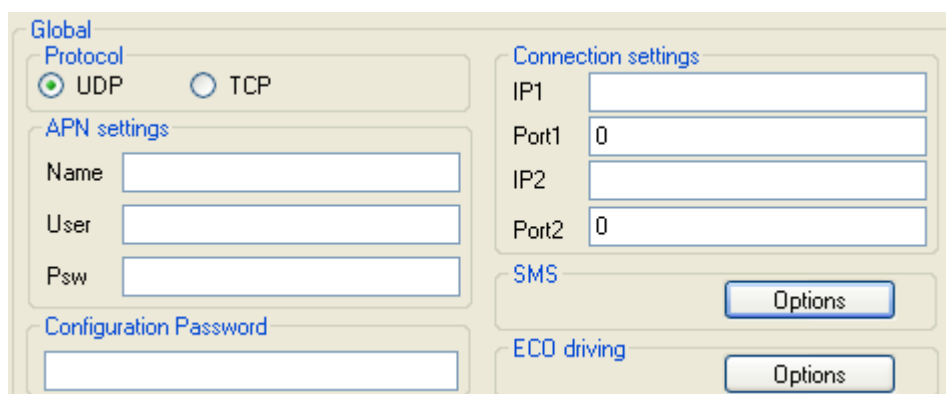

Fig. 5.3.2.1. Global parameter view

FM Manual

Protocol is a formal description of digital message formats and the rules for exchanging those messages between system's elements. This parameter sets how FM device communicates with the server. Options:

- UDP – consumes less traffic (amount of data send/received), but less reliable.
- TCP – consumes more traffic (about 30% more), but more reliable.

In case of UDP, if data is lost during transfer to server, the device will repeat the same message in next GPRS session, until transfer is successful. This means that in case of UDP there will be more retries to send, but server will receive all the data anyway.

APN (Access Point Name) is a communication protocol that allows user's device to access the internet using the mobile phone network. Name, User and Psw (password) parameters should be provided by your mobile operator as GPRS settings.

Connection settings:

- IP1 – Internet Protocol address of your server in Ipv4 form (i.e. 127.0.0.1)
- Port1 – port number through which server is accessible (i.e. 7001)
- IP2 – second Internet Protocol address of your server in Ipv4 form
- Port2 – alternative port number through which server is accessible

Firstly FM device tries to send data to IP1, if it is valid. If first 5 tries were unsuccessful, device tries to connect IP2 for five times. If tries are unsuccessful – gets back to first IP.

When connection occurred (means that device got a response to it's sent packet), device sets this IP (IP1 or IP2) as a primary IP. So all further packets are sent to this primary IP.

After firmware or configuration file update, after restart – primary IP is set to IP1 and device tries to send data to it.

You can change primary IP (a change between IP1 and IP2) with the help of SMS message. You can find examples of such messages in additional manual of SMS commands.

Configuration Password – password which restricts device configuration through USB cable. When it is not blank, you will be asked to enter the password every time when you start receiving or sending configuration session with device. Leave it blank, if you want everyone to be able to configure your device. If you forget the password, you can reset or delete it by sending configuration via GPRS from your server account, because then you will not be requested for password.

SMS are group of settings to manage your device via SMS messages. Click "Options" to see them (Fig. 5.3.2.2.). FM device can accept and send specific SMS messages, like device location information or status. In order to prevent third party eavesdropping you can restrict their usage to

up to 10 authorised numbers with one password for all of them. Device will receive and send SMS messages only from those Valid Numbers. Numbers are written without spaces and without plus sign in front (i.e. 37012312345678). Leave them blank, if you want to allow everyone to send SMS to the device. Every request with SMS must be sent with password, if device is protected. Leave it blank, if you are not using this feature.

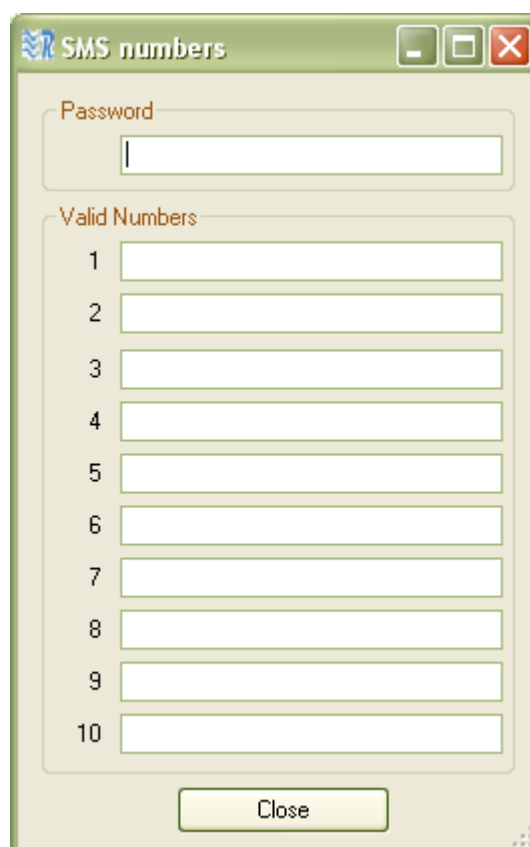

The image shows a software window titled "SMS numbers". It features a "Password" input field at the top. Below it is a section labeled "Valid Numbers" containing ten numbered input fields (1 through 10). At the bottom of the window is a "Close" button.

Fig. 5.3.2.2. SMS numbers and password

Warning! If you leave authorised number and password fields empty, then 3rd parties who know SIM card number will be able to change configuration or do any other action with the device.

ECO driving(only for PRO3 and TCO3 devices) - group of settings, where you can choose profiles with calculated parameters for trucks, light vehicles or write down your own inputs (i.e. Overspeeding limit, Harsh braking limit, etc.) for your ECO driving functionality.

5.3.3. PROFILE CONFIGURATION

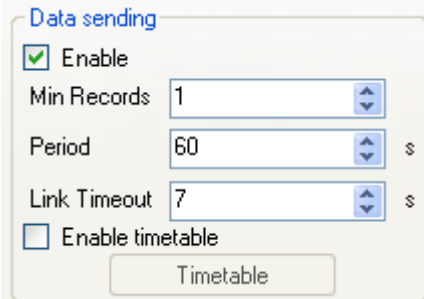

The screenshot shows a configuration window titled "Data sending". It includes the following elements:

- An "Enable" checkbox that is checked.
- A "Min Records" spinner box set to the value "1".
- A "Period" spinner box set to the value "60", followed by a small "s" indicating seconds.
- A "Link Timeout" spinner box set to the value "7", followed by a small "s" indicating seconds.
- An "Enable timetable" checkbox that is unchecked.
- A "Timetable" button located below the "Enable timetable" checkbox.

Fig. 5.3.3.1. Data sending options view

Data sending parameters (bottom left) are used to set-up sending rules. User can disable data sending via GPRS. In this case device will act as black box and only collect records. About 16000 records (without micro SD card) can be stored and after this, device will start overwriting oldest records. User also defines minimum number of records in order to start session (saves traffic if your GSM operator has a big session rounding like 10kb or 100kb) and sending period (Fig. 5.3.3.1). "Link timeout" describes, how much seconds system will wait before opening gate to send records if "Min Records" condition wasn't fulfilled. System will wait for another "Period" of time to send records if there weren't enough records for "Min records" condition after "Link Timeout" period expires. For advanced sending 44xNNDfTw/fkqDOqNTE/SDkfqaD TqfwOT /SOkNNNDfT"/OkYD

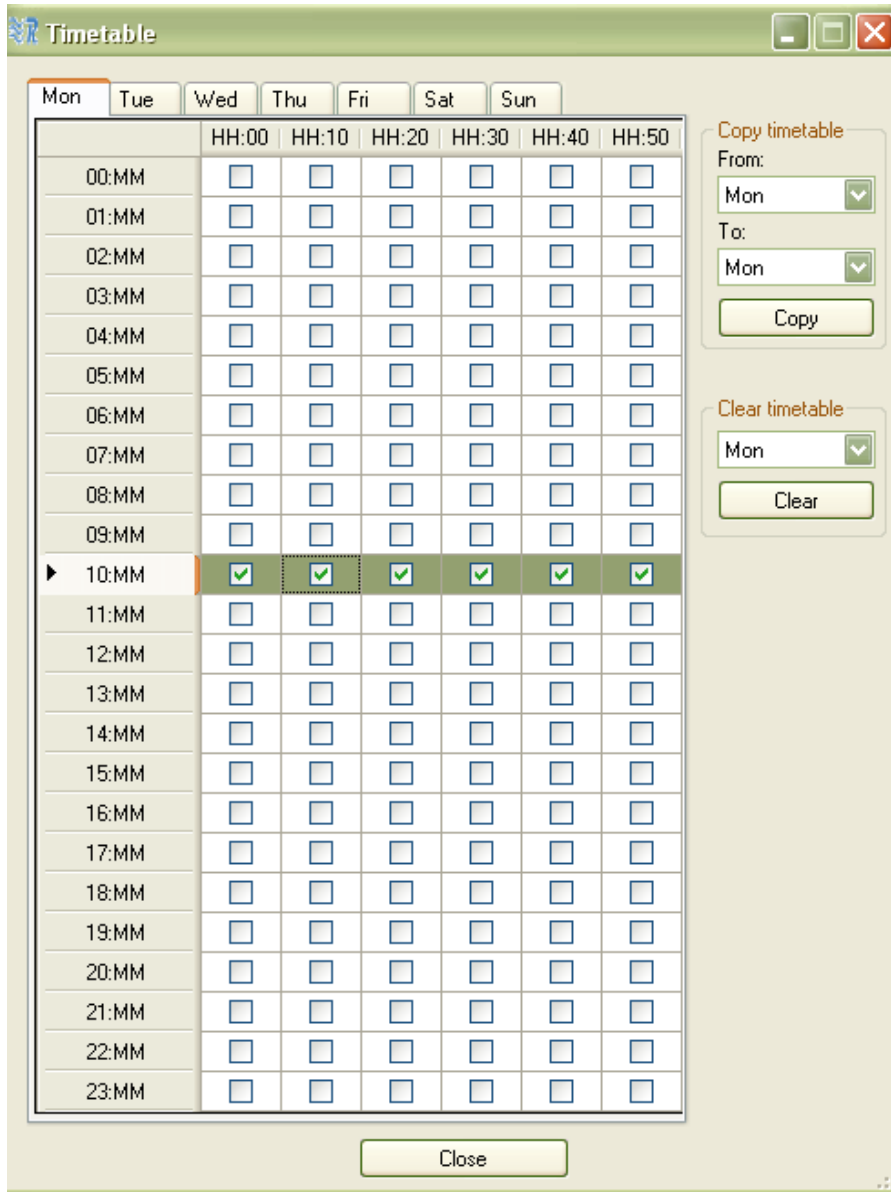

Fig. 5.3.3.2. Timetable view

FM Manual

Sleep can be enabled (Fig. 5.3.3.9) to reduce power usage of the device, but sleep also reduces response from the device, because GSM modem and GPS/GLONASS are switched off (the device does not collect records based on GPS/GLONASS information and does not respond to SMS commands). Device enters into sleep mode when no movement or ignition (depends on “Engine” selection (Fig. 5.3.3.3)) detected for 10minutes. If you have chosen “Deep sleep” – device will try to enter deep sleep mode after 10 minutes, but if there will be unsent records it will not enter it. Still, if after next 10 minutes (we mean 20 minutes in total) there will be unsent records – deep sleep mode will be enabled by force. In deep sleep, not only GPS/GLONASS module and GSM modem are disabled, but RS232, RS485, 1wire, CAN, OBD K-line and L-line interfaces are disabled too. Device resumes instantly after ignition detected.

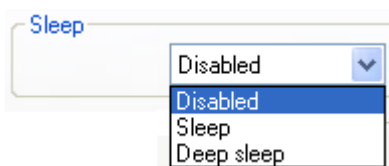

Fig. 5.3.3.9 Sleep selection buttons

Data collection parameters (bottom middle (Fig. 5.3.3.3)) are used to set-up record collection rules.

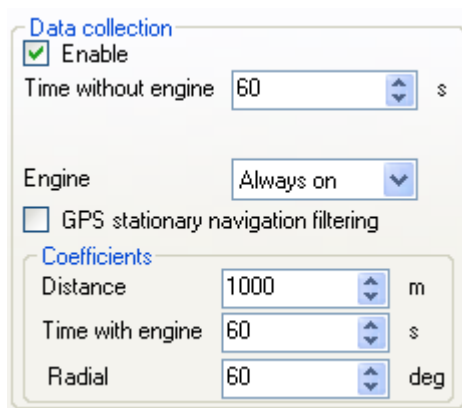

Fig. 5.3.3.3. Data collection option view

“Time without engine” sets maximum period within which device must make records. It is mostly used to make records when device is not moving, so this parameter should not be longer than “Time with engine“ in coefficients section. “Engine” selection defines how FM device detects whether it is moving or standing still, this mostly affects record collection time-out:

- “Always on” – device collects records only according to “Time with engine”(i.e. Time without engine=120s, Time with engine=60s, then it will always collect data with 60s time-out)
- “Ignition (DIN4)” – device considers that it is moving when ignition is turned on (on digital input 4 (DIN4) voltage level is high)(i.e. Time without engine=120s, Time with engine=60s, then if ignition is on time-out will be 60s, if ignition is off time-out will be 120s)
- “MovSensor” – device will take built-in movement sensor data to state if it is moving (i.e. Time without engine=120s, Time with engine=60s, then if motion sensor detects vibration, the time-out will be 60s, if no vibrations are detected - time-out will be 120s).

FM Manual

“Engine” selection also defines how device wakes up from the sleep mode. If “Ignition (DIN4)” mode is selected, then the device will wake up from high level on DIN4. Else (“Always on” or “MovSensor”) movement will be detected from built-in movement sensor.

“GPS stationary navigation filtering” function filters invalid coordinates, which can occur when GPS/GLONASS connection is low.

Coefficients section defines how often device collects records based on GPS/GLONASS readings

“Distance” parameter defines what distance a vehicle has to go to make a record. “Time” how much time must pass to make a record. “Radial” how many degrees a vehicle has to turn to make a record. All coefficients are counted from last generated record (i.e. Distance=1000m, Time=60s, Radial=60deg and device was moving for 60s, gone 650m and turned 30 degrees, so record will be made based on time, and counters will be reset, so device must go for another 1000m, or 60s, or 60deg to make another record).

FM device has a profiled structure, so according to circumstances device can send, collect and store the data in different ways. Profile switching is done in two ways: by GSM operator or by IO event. It is recommended to use single type of switching to avoid confusion. Although advanced users can combine dual switching. At first, when device starts and has no operator, it jumps to first profile. As soon as registered to a GSM network, device checks up operator lists (from 1st profile to 4th) and if it finds GSM operator code (http://en.wikipedia.org/wiki/Mobile_Network_Code) in that list, it jumps to corresponding profile. If no matching profile list is found, device jumps to first profile with empty operator list, so it is recommended to leave 4th profile with empty operator list. If the same operator code is entered in two profiles lists, then after the GSM network operator change, it will jump to first of them – let’s say operator X is listed in 2nd profile operator list and 3rd profile operator list and device works in 1st profile, when GSM operator will change to X, device will jump to 2nd profile. If using IO event switching, just set “Switch to” to desired profile (Fig. 5.3.3.6).

Operator list is placed in the middle right on the main view and is accessible by clicking options (Fig. 5.3.3.4). In the new opened window you can set up to 50 preferred mobile network operators for each profile. Operators are added as numbers (up to six digits). If you want to add Afghanistan AWCC operator, you should enter 41201 (Fig.5.3.3.5). If you want to remove operator, select operator (by clicking it on the list) and then erase it. Also you can clear all operators from the list by clicking “Clear All”. You can also click on “Enable priority in list”, so the system will choose operator, which is above in your list if more than one operator can be chosen. You can also add operators, which you don’t want to connect in a blacklist.

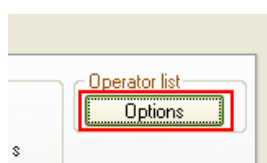

Fig. 5.3.3.4. Operator list options button

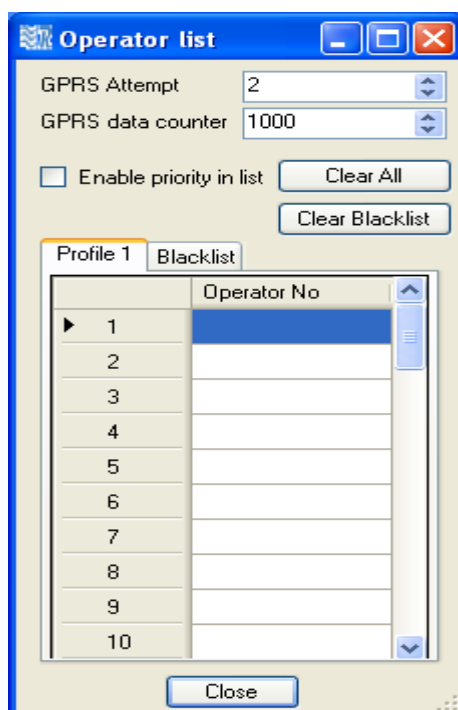

Fig. 5.3.3.5. Operator list view

IO events settings are located in the bottom right corner on the main view and are accessible by clicking “Options” button (Fig. 5.3.3.6). IO is a specific property, which can be measured by FM device and sent to server. IO event is a reaction to measured value. When IO event occurs, device makes a record into its memory with measured values, date, time and location. IO events can initiate GPRS session. Also IO can change device operation (by switching profile). You can select up to 110 IO events.

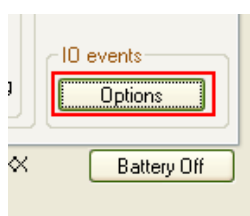

Fig. 5.3.3.6. IO events settings buttons

To add IO to data record and create IO event (Fig 5.3.3.7):

- Select space for IO. If it is “Disabled” then it is empty and new IO will be added, otherwise you will overwrite IO and it will be replaced with new one.

FM Manual

- Check “Enable”.
- Select property ID you want to measure.
- Set “Level” (optional, used for Hysteresis (explained below), IO dependant).
- Set “Delta” (optional, used for Hysteresis (explained below), IO dependant).
- Set “Average” (averaging is used to ensure that IO value is long time result and not short impulse value). Some parameters, which has static values (like iButton ID) ignores averaging.
- Select “Event on”(Monitoring – no event generation, only include value to record; Hysteresis – event generation defined by “Level” and “Delta”; Change – event generated when measured property changes, that means its value is different from previous registered value).
- Select whether to always include value to record or only when event is generated.
- Select priority (Low – do not start GPRS session after event and send data according to timing defined in parameters “Period” and “Timetable”(Fig. 5.3.3.1.), High – start GPRS session after event and send data if “Timetable” allows GPRS activity at that time).
- Select whether to switch profile on this event or not.

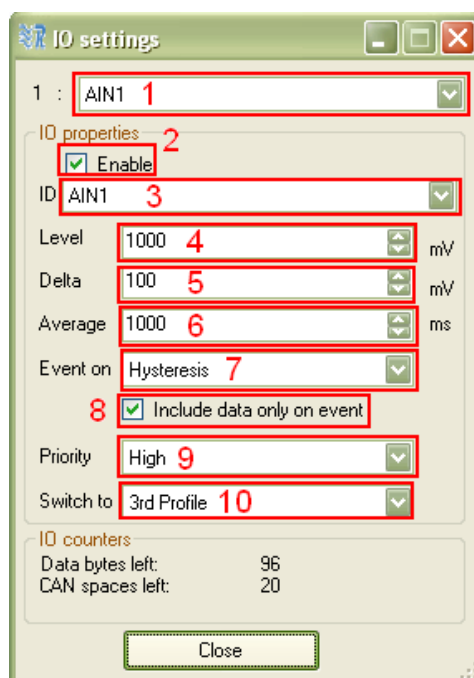

Fig. 5.3.3.7. IO events settings buttons

Hysteresis principle is applied to reduce amount of events generated and thus reduce GPRS traffic. For example, take configuration from Fig. 5.3.3.7: voltage on analogue1 input (AIN1) will be measured, event will be generated on hysteresis then signal on analogue rises from $1000-100=900\text{mV}$ to $1000+100=1100\text{mV}$, or falls from 1100mV to 900mV , with samples averaged within 1s intervals; data will be included only when event is generated; and when an event is generated, GPRS session will be initiated and device will switch to 3rd profile. To generate event on “Hysteresis” property value must travel from Level-Delta to Level+Delta or vice versa. In Fig. 5.3.3.8 event will be generated on 9th and 15th seconds.

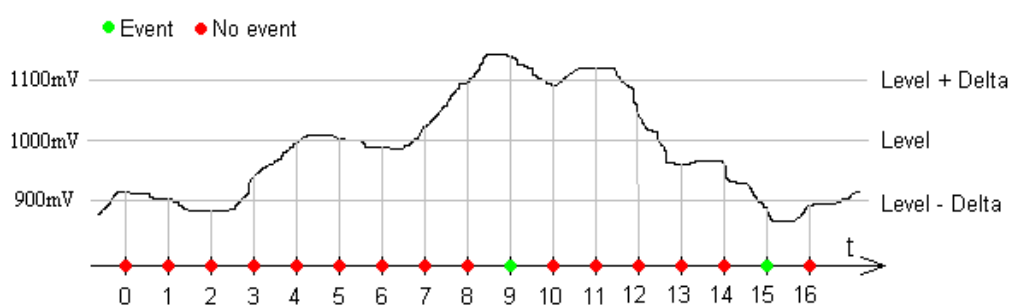

Fig. 5.3.3.8. Hysteresis explanation

Some IO options have conventional parameter measurement units (analogue inputs, temperature measurements, etc.) while others are defined in specific standards (as CAN FMS 2.0).

CANbus parameters settings. settings are located in the bottom right corner on the main view and are accessible by clicking “Options” button (Fig. 5.3.3.6). For different vehicles, different settings must be used.

Different devices supports different type of CANbus:

PRO3 – supports only FMS standard CANbus;

TCO3 – supports FMS standard CANbus, CANbus OBD, OBD through K-line, light and commercial vehicles (LCV) CANbus and other types of CANbus. More information about CANbus supported vehicles, please ask Ruptela support team support@ruptela.com.

upports FMS standard CANbus for light and commercial vehicles (LCV) CANbus and other types of CANbus. More information about CANbus supported vehicles, please ask Ruptela support team support@ruptela.com.

To set CANbus parameters correctly for PRO3 units, please see an example Fig. 5.3.3.9.

To set CANbus parameters correctly for TCO3 units, please see an example Fig. 5.3.3.10.

FM Manual

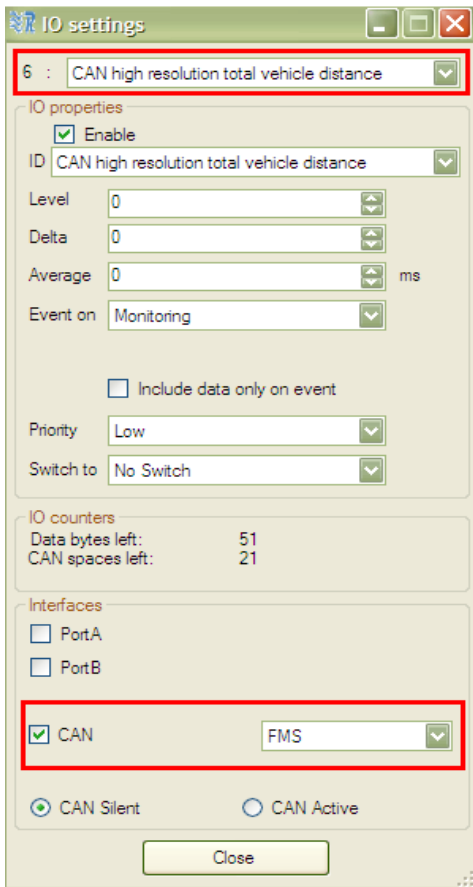

Fig. 5.3.3.9. FMS standard CANbus settings

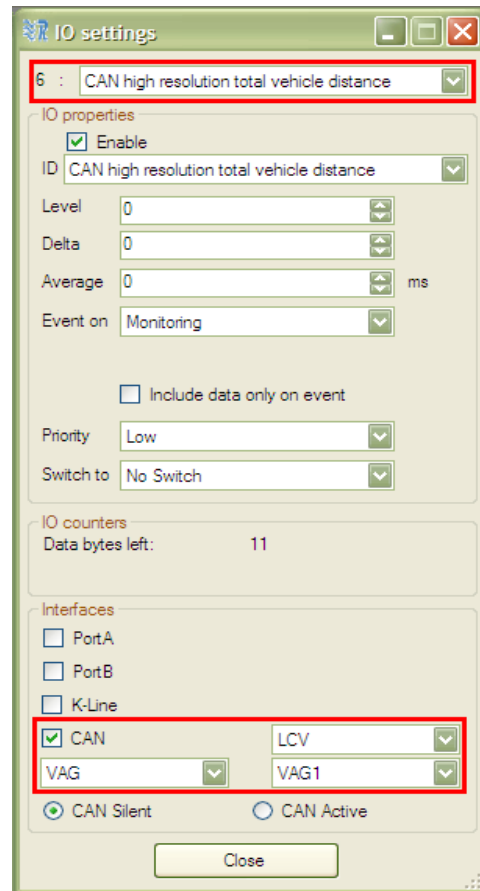

Fig. 5.3.3.10. LCV CANbus settings

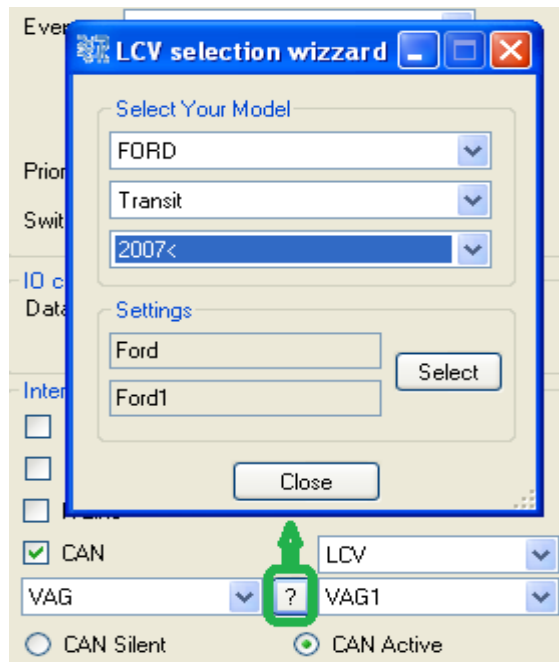

Fig. 5.3.3.11 LCV CANbus settings

FM Manual

You can also select “?” for help in configuration (fig. 5.3.3.11). PRO3, TCO3 units can read CANbus from vehicles in Silent and in Active mode. CAN Silent – means device is not communicating with vehicle Board computer, it only listens for the data which is on CANbus line.

CAN Active - this type of CAN communication is when our device communicates with Board computer and sends commands to get one or another CANbus parameter from Board computer. Mostly this is used when OBD connection is used or some extra (third part) CANbus converter between vehicle and PRO3,TCO3 devices is connected.

5.3.4. SAVING AND LOADING CONFIGURATION

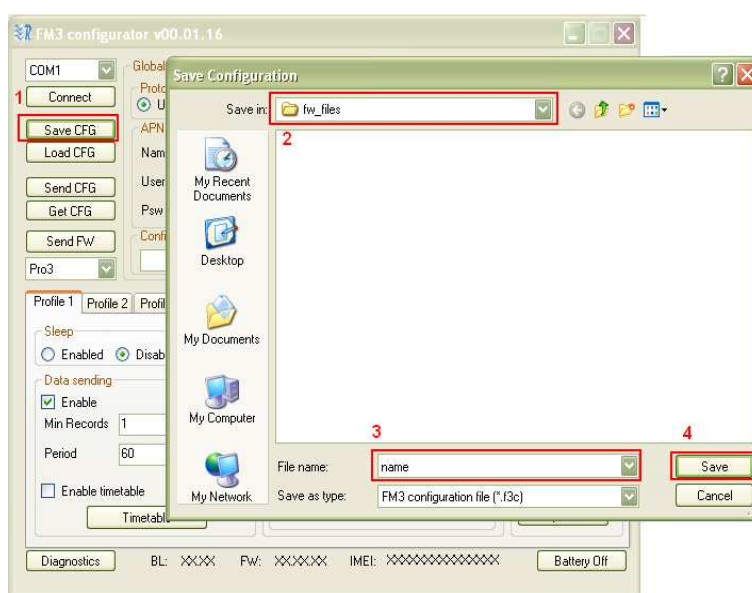

Fig. 5.3.4.1. Configuration saving scheme

In the main view upper left corner there are “Save CFG” and “Load CFG” buttons, which save and load configuration files. In order to save file click “Save CFG”, go to folder where to save configuration, give name to file and click “Save” (Fig. 5.3.4.1). In order to load configuration, click “Load CFG”, navigate to folder where configuration file is saved, select file and click “Open”.

& : 9 " 1 * \$

(K / 0 0 11 * * 1 > 11 * =
5 \$ 5 / 1 \$ * 1 ;1 : 9 <

& : 9 - 11 *

Both actions, saving and loading, can be completed whether the device is connected or disconnected from PC.

Different device types (FM-Eco3, FM-Pro3, FM-Tco3) have slightly different configuration options. So when configuring without connected device, pay attention to which type is selected (Fig. 5.3.4.2.). Each device type has its own configuration file extension: FM-Eco3 – .fe3c, FM-Pro3 – .fp3c, FM-Tco3 – .ft3c.

5.3.5. SAVING AND LOADING CONFIGURATION

In the main view upper left corner there are “Send CFG” and “Get CFG” buttons, which are responsible for configuration exchange with device. These actions can only be performed when connected to COM port (chapter 5.3.1). In order to get configuration from device click “Get CFG” button. The controls will be frozen for a while and

After sending firmware file to the device, notification will pop up on the bottom of the device and LEDs will glow continuously for about a minute. Firmware update takes up to 5 minutes, so device must be powered up during that time. Device is completely ready to use when LEDs start blinking.

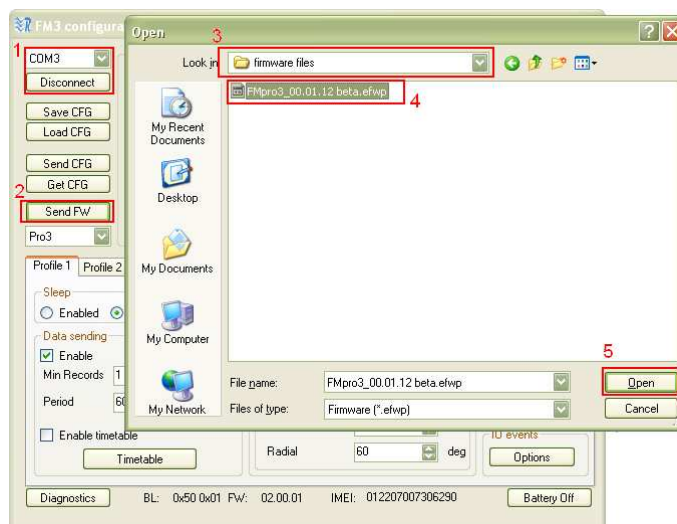

Fig. 5.4.2. Firmware update scheme

FM Manual

5.5. APPENDIX – IO LIST

IO name	IO size, B	IO value range	IO value explanation	Notes
AIN1	2	0-65535	mV	
AIN2	2	0-65535	mV	
Accelerometer X	1	-127...127	Acceleration in X direction	0,05 bitgain
Accelerometer Y	1	-127...127	Acceleration in Y direction	0,05 bitgain
Accelerometer Z	1	-127...127	Acceleration in Z direction	0,05 bitgain
Battery current	2	0-65535	mA	Should not exceed 250mA
Battery Voltage	2	0-65535	mV	Should be between 3300 and 4300mV
CAN accelerator pedal position 1	1	0-255	0-100% pressed, by 0,4% steps	128=51% - pedal pressed to the middle
CAN ambient air temperature	2	0-65535	0.03125 °C/Bit gain -273 °C offset	9376=20°C
CAN at least one PTO engaged	1	0-3	0=No PTO drive is engaged 1=At least one PTO drive is engaged 2=Error 3=Not available	
CAN axle location	1	0-15	Defined in FMS 2.0 standard	
CAN axle weight	2	0-65535	0.5 kg / Bit gain	20000=10000kg
CAN brake switch	1	0-1	0=pedal released 1=pedal pressed	
CAN clutch switch	1	0-1	0=pedal released 1=pedal pressed	
CAN cruise control active	1	0-1	0=switched off 1=switched on	
CAN diagnostics supported	1	0-3	0=diagnostics is not supported 1=diagnostics is supported 2=reserved 3=don't care	
CAN engine coolant temperature	1	0-255	1°C / Bit gain -40°C offset	128=88°C

FM Manual

IO name	IO size, B	IO value range	IO value explanation	Notes
CAN engine speed	2	0-65535	0.125 rpm / Bit gain	8000=1000rpm
CAN engine hours	4	0-4294967295	0.05 h / Bit gain	200000=10000h
CAN engine percent load at current speed	1	0-125	1%/bit, 0 to 125% op. range	60=60%
CAN engine total fuel used	4	0-4294967295	0,5 L / Bit gain	20000=10000L
CAN first driver ID	16	-	Driver ID = Card Number	
CAN fuel level1	1	0-255	0,4 % / Bit gain	128=51%
CAN fuel rate	2	0-64255	0.05L/h per bit 0 to 3212,75L/h	600=30L/h
CAN high resolution engine total fuel used	4	0- 4211081215	0.001 L/bit 0 to 4211081,215 L	1000000=1000L
CAN high resolution total vehicle distance	4	0-4294967295	5 m/Bit gain	10000=50000m
CAN instantaneous fuel economy	2	0-64256	1/512 km/L per b 0 to 125,5 km/L	2560=5km/L
CAN requests supported	1	0-3	0=request is not supported 1=request is supported 2=reserved 3=don't care	
CAN second driver ID	16	-	Driver ID = Card Number	

FM Manual

IO name	IO size, B	IO value range	IO value explanation	Notes
CAN tacho driver 1 card	1	0-1	0=Card not present 1=Card present	
CAN service distance	2	0-65535	5 km / Bit gain -160 635 km offset	32327=1000km (negative means service passed)
CAN system event	1	0-1	0=no tachogr. Event 1=tachogr. Event	
CAN SW-version supported	4		Defined in FMS 2.0 standard	
CAN tacho direction indicator	1	0-1	0=Forward 1=Reverse	
CAN tacho driver 1 time related status	1	0-15	0=normal 1=15 min bef. 4 ½ h 2=4 ½ h reached 3=15 min bef. 9 h 4=9 h reached 5=15 min bef. 16 h 6=16h reached 14=Error 15=not available	
CAN tacho driver 2 card	1	0-1	0=Card not present 1=Card present	
CAN tacho driver 2 time related status	1	0-15	0=normal 1=15 min bef. 4 ½ h 2=4 ½ h reached 3=15 min bef. 9 h 4=9 h reached 5=15 min bef. 16 h 6=16h reached 14=Error 15=not available	

FM Manual

IO name	IO size, B	IO value range	IO value explanation	Notes
CAN tacho vehicle overspeed	1	0-1	0=No overspeed 1=Overspeed	
CAN tacho driver1 working state	1	0-7	0=Rest 1=Driver available 2=Work 3=Drive 6=Error 7=not available	
CAN tacho driver2 working state	1	0-7	0=Rest 1=Driver available 2=Work 3=Drive 6=Error 7=not available	
CAN tacho handling information	1	0-1	0=no handling information 1=handling information	
CAN tacho vehicle motion	1	0-1	0=Vehicle motion not detected 1=vehicle motion detected	
CAN tachograph performance	1	0-1	0=Normal performance 1=Performance analysis	
CAN tachograph vehicle speed	2	0-65535	1/256km/h Bit gain	15360=60km/h
CAN tire location	1	0-15	Defined in FMS 2.0 standard	
CAN vehicle ID	24	-	Defined in FMS 2.0 standard	

FM Manual

IO name	IO size, B	IO value range	IO value explanation	Notes
CAN wheel based speed	2	0-65535	1/256km/h Bit gain	15360=60km/h
Current profile	1	0-4	0=default pfile 1=1st profile 2=2nd profile 3=3rd profile 4=4th profile	
Digital Fuel Sensor A1	2	0-1023	Relative to size	1023= full, 0= empty
Digital Fuel Sensor A2	2	0-1023	Relative to size	1023= full, 0= empty
Digital Fuel Sensor A3	2	0-1023	Relative to size	1023= full, 0= empty
Digital Fuel Sensor A4	2	0-1023	Relative to size	1023= full, 0= empty
Digital Fuel Sensor A5	2	0-1023	Relative to size	1023= full, 0= empty
Digital Fuel Sensor A6	2	0-1023	Relative to size	1023= full, 0= empty
Digital Fuel Sensor A7	2	0-1023	Relative to size	1023= full, 0= empty
Digital Fuel Sensor A8	2	0-1023	Relative to size	1023= full, 0= empty
Digital Fuel Sensor A9	2	0-1023	Relative to size	1023= full, 0= empty
Digital Fuel Sensor A10	2	0-1023	Relative to size	1023= full, 0= empty
Digital Fuel Sensor B	2	0-1023	Relative to size	1023= full, 0= empty
Din1 Hour counter	4	0-4294967295	Time counter when Din is in high state in seconds	

FM Manual

IO name	IO size, B	IO value range	IO value explanation	Notes
Din2 Hour counter	4	0-4294967295	Time counter when Din is in high state in seconds	
Din3 Hour counter	4	0-4294967295	Time counter when Din is in high state in seconds	
Din4 Hour counter	4	0-4294967295	Time counter when Din is in high state in seconds	
DIN1	1	0-1	0=low level on input 1=high level on input	
DIN2	1	0-1	0=low level on input 1=high level on input	
DIN3	1	0-1	0=low level on input 1=high level on input	
ECO brake counter	1	0-255	Braking event counter	
ECO cruise control timer	4	0-4294967295	Split parameter for time when cruise control was on and cruise control should be on	
ECO engine on timer	2	0-65535	Time when engine was on	
ECO extreme and harsh brake counter	1	0-255	Split counter for extreme and harsh braking	
ECO idling timer	2	0-65535	Time when engine was idling	
ECO max RPM	2	0-65535	Maximum RPM value	
ECO max speed	1	0-255	Maximum speed value	

FM Manual

IO name	IO size, B	IO value range	IO value explanation	Notes
GSM signal level	1	0-31	0=-115dBm or less 1=-111dBm 2...30=-110...-54dBm 31=-52dBm or greater 99=not known or detectable	
ECO overspeeding timer	2	0-65535	Time whed speed was above limit	
ECO RPM in red band timer	2	0-65535	Time when RPM was not optimal	
Fuel Counter 1	2	0-65535	Depends on Counter	
Fuel Counter 2	2	0-65535	Depends on Counter	
GPS speed	1	0-255	Value km/h	
GSM operator	4	0-4294967295	Unique Mobile operator code	http://en.wikipedia.org/wiki/Mobile_Network_Code
iButton ID	8	-	Unique iButton ID	
Ignition(DIN4)	1	0-1	0=low level on input 1=high level on input	
Movement sensor	1	0-1	0=No motion detected 1=Motion detected	
Modem temperature	1	-40-90	°C	
PCB temperature	1	-40-80	°C	
Power supply voltage	2	0-65535	mV	
TCO distance	4	0-4294967295	5 m/Bit gain	10000=50000m
TCO engine speed	2	0-65535	0.125 rpm / Bit gain	8000=1000rpm

FM Manual

IO name	IO size, B	IO value range	IO value explanation	Notes
TCO first driver card	1	0-1	0=Card not present 1=Card present	
TCO first driver ID	16	-	Driver ID = Card Number	
TCO first driver state	1	0-7	0=Rest 1=Driver available 2=Work 3=Drive 6=Error 7=not available	
TCO registration number	16	-	License plate number	
TCO second driver card	1	0-1	0=Card not present 1=Card present	
TCO second driver ID	16	-	Driver ID = Card Number	
TCO second driver state	1	0-7	0=Rest 1=Driver available 2=Work 3=Drive 6=Error 7=not available	
TCO first driver card	1	0-1	0=Card not present 1=Card present	
TCO first driver ID	16	-	Driver ID = Card Number	
TCO first driver state	1	0-7	0=Rest 1=Driver available 2=Work 3=Drive 6=Error 7=not available	
TCO registration number	16	-	License plate number	
TCO second driver card	1	0-1	0=Card not present 1=Card present	

FM Manual

IO name	IO size, B	IO value range	IO value explanation	Notes
TCO second driver ID	16	-	Driver ID = Card Number	
TCO trip distance	4	0-4294967295	5 m/Bit gain	10000=50000m
TCO vehicle ID	24	-	Defined in FMS 2.0 standard	
TCO vehicle speed	2	0-65535	1/256km/h Bit gain	15360=60km/h
Temperature sensor0	2	-550-1250	0,1 °C / Bit gain	200=20°C 2001 – 1wire bus short-circuit 2002 – CRC error 2003 – no sensors 2004 – abnormal temperature
Temperature sensor0 ID	8	-	Unique temperature sensor ID	
Temperature sensor1	2	-550-1250	0,1 °C / Bit gain	200=20°C 2001 – 1wire bus short-circuit 2002 – CRC error 2003 – no sensors 2004 – abnormal temperature
Temperature sensor1 ID	8	-	Unique temperature sensor ID	
Temperature sensor2	2	-550-1250	0,1 °C / Bit gain	200=20°C 2001 – 1wire bus short-circuit 2002 – CRC error 2003 – no sensors 2004 – abnormal temperature
Temperature sensor2 ID	8	-	Unique temperature sensor ID	
Virtual odometer	4	0-4294967295	m	